



D 250 AHG
D 350 AHG
D 400 AHG
D 450 AHG



OPERATOR'S MANUAL

ENGLISH
Original Manual





D 250 AHG
D 350 AHG
D 400 AHG
D 450 AHG

Original manual

4



D 250 AHG / D 350 AHG / D 400 AHG / D 450 AHG

Updates chart

Date	Version	Actualization
20/02/18	1st	<ul style="list-style-type: none"> - Add new models D 250 AHG y D 450 AHG - Add documents holder. - Add symbols used. - Add recommendations for driving in slopes. - Add new specifications chart - Remove electric and hydraulic diagrams. <p>Based on the following publication:</p> <ul style="list-style-type: none"> - D 350 AHG / D 400 AHG_ES - Version MOP 260617 07 - D 250 AHG / AHGA_ES - Version MOP 100417 03

Foreword

■ Thank you for choosing this AUSA dumper model which offers the best levels of performance, safety and working comfort. Remember that you are the key to maintaining these characteristics. Correct use of the dumper will enable you to take full advantage of the features it has to offer.

You should read and understand this manual before operating the dumper. Its purpose is to provide instructions for those persons in contact with the vehicle and especially for the vehicle operator. Its content will help you to better understand the AUSA dumper, and teach all you need to know about starting the vehicle, driving techniques, maintenance and care, intended uses of the vehicle and safety instructions to be followed.

AUSA cannot be held responsible for any damages caused by the improper use of the vehicle.

For any inquiries, complaints or spare parts orders, contact your authorized AUSA importer or dealer.

For further information you may call, write, FAX or email to:

AUSA Center, S.L.U.

P.O.B. 194

08243 MANRESA (Barcelona), SPAIN

Tel. 34-938 747 552 / 938 747 311

Fax 34-938 736 139 / 938 741 211 / 938 741 255

E-mail: ausa@ausa.com

Web: <http://www.ausa.com>

AUSA is continuously improving its products and reserves the right to make such improvements without incurring any obligation to make changes to dumpers previously sold. Claims therefore cannot be made based on the data, illustrations and descriptions set forth in this manual.

Use only original AUSA spare parts. This is the only way you can guarantee that the dumper will continue to operate at the same level of technical performance as when purchased.

No changes should be made to the dumper without prior authorization from the manufacturer.

Keep this manual in the document carrier, located underneath the engine right cover (standard machine) **(fig. 1)**.

As optional equipment or for special finishing it is offered a documents holder for manuals in the left side of the bonnet **(fig. 2)**.

To open the manuals holder, pull the attaches **(a)** **(fig. 3)** and open the cover.

The manual holder has an anti-vandal system to insert a lock or similar **(b)** **(fig. 3)**.

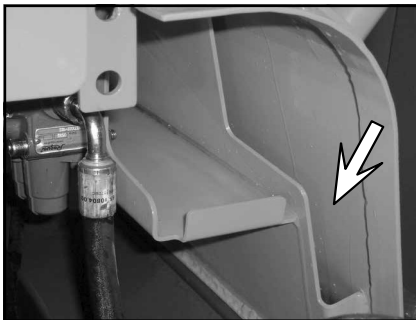

(fig. 1)



(fig. 2)

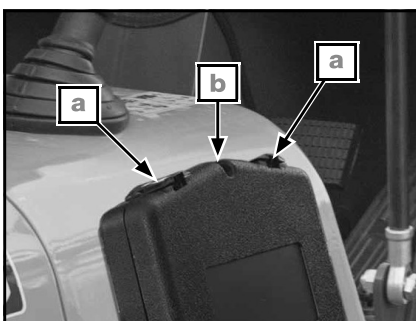

(fig. 3)



D 250 AHG / D 350 AHG / D 400 AHG / D 450 AHG

Symbols

When using the dumper, you may find yourself in situations in which specific considerations or explicit explanations are required.

This manual marks situations involving a risk to your safety, the safety of others, or the operating order or correct use of the machine, this manual uses SPECIAL SYMBOLS and includes specific instructions.

Although simply reading this information will not remove the risk, understanding and applying the markings will assist in the correct use of the machine.

Five special (safety) symbols are used in the manual. These symbols are displayed with key words classifying the degree of danger involved. Each symbol will assist in identifying the corresponding risk and indicates the action to be taken to avoid the risk. The text may be accompanied by illustrations in some cases.

The following is a list of the special (safety) symbols in order of importance:

	DANGER	
Indicates situations which, if the appropriate safety precautions are not taken for yourself and others, imply serious risks for the physical integrity of the people involved, and may even include a risk of death.		
	WARNING	
Indicates situations relating to your safety and that of others, which imply low risks of accidents or injury, or the ineffective operation of the machine.		
CAUTION		
Indicates situations relating to the operation of the machine.		
	ENVIRONMENTAL PROTECTION	
The text following this symbol includes information on recycling and environmental information.		
NOTE		
Indicates any additional information required to complete instructions.		

D 250 AHG / D 350 AHG / D 400 AHG / D 450 AHG



Symbols



WARNING



When reading this manual, pay close attention to the special symbols and explanations next to these symbols.



Index

Updates chart.....	4
Foreword	5
Symbols	6
Index.....	8
Designed use and improper use of the dumpers.....	9
Special safety messages	10
Plates and adhesives	17
Specifications	21
How to identify the Dumper	25
Controls / Instruments / Equipments	26
Operating the dumper.....	41
Break-in period	46
Before starting the dumper	47
Transporting the dumper.....	48
Fluids and lubricants	51
Special procedures	53
Periodic maintenance operations	55
Lubrication and maintenance chart	76
Greasing points.....	78
Electric diagram / Hydraulic diagram	79
Identification of failures in hydrostatic transmissions	80
EC certificate of conformity.....	81

Designed use and improper use of the dumpers

■ Designed use

The dumpers are designed and manufactured for the transport, dumping or scattering of loose materials, (mortar, cement, sand, gravel and rubble or materials from demolitions). To a lesser extent it is used in work related to gardening, forestry and others.

Any other use is considered to lie outside of the intended use and therefore constitutes improper.

Close adherence to the operation, maintenance and repair conditions specified by the manufacturer is essential for good use of this vehicle.

Driving, maintenance and repair of the dumper must only be entrusted to appropriately trained personnel, who possess the required tools and know the intervention and safety procedures relating to the dumper.

Health and safety at work and accident prevention standards should be respected during all transport, maintenance or repair operations. When driving on public roads current legislation must be adhered to (Highway Code).

AUSA is not responsible for any possible harm caused by any modification carried out on the dumper without their express authorization.

■ Improper use

Improper use is understood to be the use of the dumper in a way that does not comply with the criteria and instructions of this manual and usage in a way that may cause harm to persons or items.

The following are some of the most frequent and dangerous instances of improper use:

- Transporting people in the skip or in any parts of the body, apart from the driver.
- Failing to carefully comply with the instructions for use and maintenance set out in this manual.
- Overloading
- Working on unstable loose ground or on the edge of ditches and trenches.
- Using accessories and equipment for purposes other than those they are designed for.
- Using accessories and equipment not manufactured or authorized by AUSA.

Basically, it must be used as described in this operator's manual, the general rules on accident prevention and any other approved standards for safety and occupational health.

Maintenance and repair should only be performed by qualified personnel of the manufacturer.



Special safety messages

■ AUSA manufactures its dumpers in accordance with requirements for intrinsic protection, as established in current law for countries of the European Economic Community. AUSA dumpers are manufactured to guard against dangers of any kind that could present a health risk or be life-threatening, when the machine is used and maintained in accordance with these directives. Any hazard caused by improper use, failure to comply with these instructions or failure to comply with other instructions specifically provided with the dumper are the responsibility of the user and not AUSA.

This section gives instructions on how the dumper must be used as per that contained in the 2006/42/EC Machine Safety Directive.

■ As a driver, think about...

- Before you begin using a dumper that you are not yet familiar with, you should read this operator manual carefully and consult your superior if you have any doubts (**fig. 1**). The dumper should only be used by authorized and appropriately trained personnel.
- Make sure that you are issued all the necessary protective gear to enable you to carry out your work safely. This could include a hard hat, ear protectors, warm clothes, reflective equipment, goggles, etc. (**fig. 2**).
- It is not recommended that you operate of the dumper while wearing bracelets, chains, loose clothing, long hair that is not tied back, etc. since these things could be caught in controls, rotating parts, cracks, etc.

■ Depending on the work environment, remember....

- If there is a risk of fire or explosion in the working environment, arising either from goods stored or because of possible fluid or gas leaks, check that the dumper is equipped with sufficient fire protection.
- In dumpers equipped with exhaust particulate filter (DPF), disable the regeneration while staying in these risk areas.
- The exhaust gas from the muffler is very hot. To prevent a fire, do not expose dry grass, mowed grass, oil or any other combustible materials to exhaust gas. Keep the engine and muffler clean at all times.
- If you have to work in closed spaces, make sure that the area is well ventilated in order to prevent the excessive build-up of exhaust fumes. Always turn the engine off when it is not needed.
- To drive the dumper on public roads, all necessary approvals and licenses must be obtained in accordance with the current country legislation, including the signalling and safety elements included in the legislation.
- Current legislation does not call for a structure to be mounted for protection against falling objects as a standard requirement. However, if you must use the dumper in areas associated with a risk of this type, the same legislation indicates that you must equip the machine with such a structure.
- Use of the dumper without lighting is permitted in full daylight or in areas which are sufficiently lit.



(fig. 1)

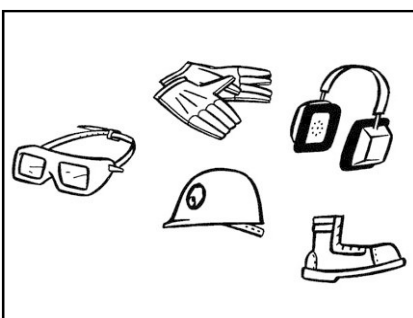

(fig. 2)

! Special safety messages

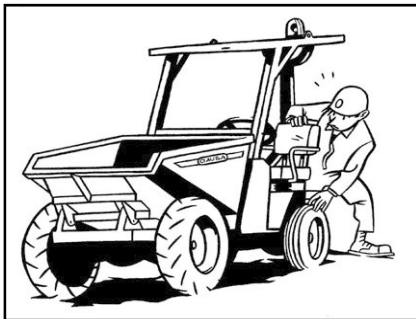

(fig. 1)



(fig. 2)

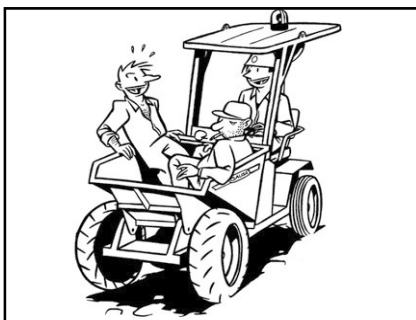

(fig. 3)

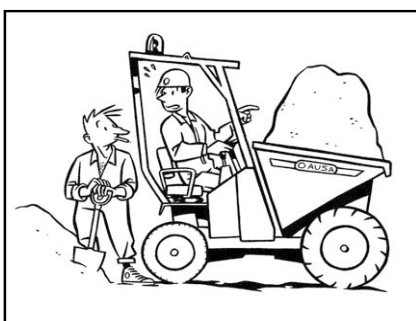

(fig. 4)

■ When starting up the dumper (fig. 1)

- Before starting work with the dumper, clean up any possible oil or fuel that may have leaked, clean and remove any grease from your hands and the soles of your shoes, and remember to check the following items:
 - Tire pressure and tread condition.
 - Check brake functioning.
 - Check for any leaks in the hydraulics, fuel, and cooling systems, etc.
 - Check that all protectors, covers, and safety end stops are correctly positioned and properly attached.
 - Check that there are no cracks or other structural defects visible to the naked eye.
 - Check that all controls are operating properly.
 - Check the following fluid levels:
 - fuel
 - brake fluid
 - Hydraulic oil
 - Coolant
 - Check that the seatbelt and its mounting is in good condition and properly fixed. Carefully inspect the condition of these devices with special attention to:
 - Cuts or threading on the belt
 - Wear or damage to anchor points
 - Poor functioning of the seat belt buckle or the retracting roller
 - Loose threads or poor stitching
 - Check that all covers, locks and other safety elements are correctly positioned.
 - Check that alarms and signalling devices are functioning properly (for example: acoustic warning, obstruction indicator for the air admission filter, etc.)
 - Check that all the information and safety advice plates on the dumper are clean and in good condition.
 - Check that the lighting and signalling system is clean and working properly (if fitting)
 - Check battery connections.
 - Adjust the seat position so that you are comfortable and can easily reach the controls.
 - Do not start the engine or operate the controls unless you are seated in the cab.
 - For your safety in the case that the dumper overturns, do not forget to correctly adjust and fasten the seat belt.
 - Keep the driving area clear of all objects or tools that could move about and might obstruct a control and prevent you from carrying out a maneuver when required.
- (fig. 2)**
- Always stop the engine before refuelling and never smoke during the process. Do not mix gasoline or alcohol with the fuel

■ When operating the dumper, do not forget...

- If you notice any anomaly while using the dumper, inform your superior or maintenance service immediately.
- Yield right of way to any pedestrians you might come across while driving.
- The dumper must not be used to transport people, other than the driver, unless adequate seats have been provided for that end **(fig. 3)**.
- Do not overload the dumper.
- Ensure that you have good visibility of the track, if the load obstructs visibility, drive in reverse gear and be extra cautious **(fig. 4)**.



Special safety messages

- When approaching an intersection with poor visibility, slow down, sound your horn and move forwards slowly in accordance with your level of visibility.
- Check that the traction on the ground on which you are driving is sufficient for the loaded dumper, this is especially important on access to bridges, embankments, slabbed areas, loading areas, etc **(fig. 1)**.
- Before reversing the dumper, the operator should check that doing so will not put either the machine itself or nearby people or objects at risk **(fig. 2)**.
- Do not drive with the skip raised.
- Do not activate two skip movements simultaneously.
- Keep your mind completely on the job at hand. The safety of both the driver and others depends on the care taken when driving **(fig. 3)**.
- When circulating around the public routes with dumper circularly with the adjustable hopper to 180°, the longitudinal axis of the same one must be oriented
- Depending on the ground, try to raise as little dust as possible while moving about.
- The dumper is not a machine designed for towing other dumpers. If this is unavoidable, place a certain amount of load in the cargo box to ensure traction.
- Drive carefully and at a reduced speed; and if the tow load is not equipped with an overrun brake, make sure that the brakes are strong enough for both the dumper mass and that of the tow load.
- To use the mobile phone while driving, you must have a free hands system.

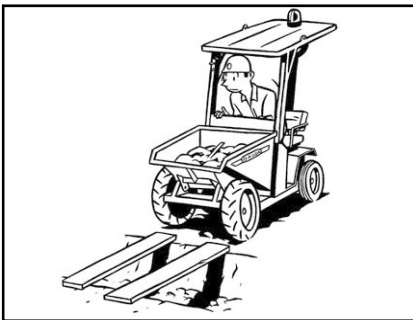

(fig. 1)

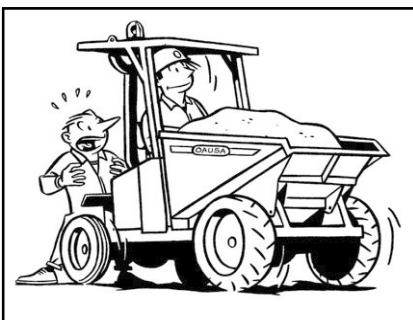

(fig. 2)

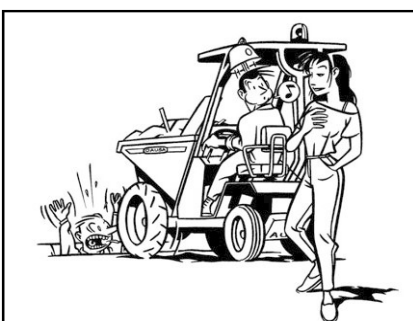

(fig. 3)

! Special safety messages



(fig. 1)



(fig. 2)

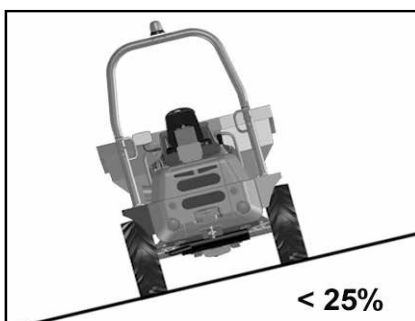

(fig. 3)

■ Driving in slopes

Safety instructions to have in mind during the operation in slopes

!	DANGER	!
Danger of crushing in the event of machine overturning!		
The overturning of the machine can cause serious injury or event death.		

- Pay special attention during the operation in slopes
- A slope within the recommended gradient does not mean that this slope manoeuvred on with absolute safety under any load, terrain or handling conditions. Do not operate slopes which exceed the recommended gradient.
- Always place the machine in the position to enter the slope in a straight line.
- Slopes should only be negotiated if the ground is stable.
- The speed of the dumper should be adjusted at all times to the work conditions and the area where it is being carried out. Regularly driving the machine at maximum speed may represent a danger to the operator and to his or her surroundings.
- Carry out manoeuvres gently, especially when changing direction on slippery ground.
- Ascend and descend slopes only in slow driving speed.
- Respect the machine stability limits (maximum ramp angle 25% and maximum lateral inclination angle 25%).
- Pay attention to people and obstacles.
- Keep hands, feet and the whole body in general inside the area provided for the operator.
- Do not exceed the maximum payload.
- When ascending and descending slopes, do not rotate or rise the skip.
- When operating in slopes, the hopper should be raised only for tipping.
- Avoid as far as possible travelling across slopes.
- The presence in the surface of stones and wet can impair the traction and stability of the machine.
- The presence in the surface of stones and wet can impair the traction and stability of the machine.
- The machine can skid laterally on stony grounds. In uneven terrain, the machine may lose stability.
- On soft grounds, the machine sinks and the wheels get stuck. This increases the angle of the machine (maximum ramp angle and maximum lateral inclination angle), which may cause it to tip-over.
- If the engine suddenly stops when ascending or descending a slope, put immediately the forward – reverse selector in NEUTRAL and re-start the engine.
- The machine can slip sideways even on steep slopes (above grass, brush, damp metal surfaces, frozen ground, snow, etc.).

Operating on slopes with the skip loaded

When operating on slopes with the skip loaded, the skip must always face uphill, regardless of the driving direction. In any case, it is not recommendable to overcome a maximum slope of 25% (**fig. 1**).

Operating on slopes with the skip unloaded

When operating on slopes with the skip unloaded, the skip must always face downhill, regardless of the driving direction. In any case, it is not recommendable to overcome a maximum slope of 25% (**fig. 2**).

Driving across slopes

It is not recommendable to drive with lateral inclinations steeper than de 25%. Make the change of position in flat terrain to enter the slope in a straight line (**fig. 3**).



Special safety messages

■ **Take care when loading and unloading the dumper...**

- Do not empty the contents of the skip near a bank that is not reinforced, and make sure there is a safety stop bar for the wheels at a safe distance from the edge. An 8 cm side board cannot be considered an acceptable stopping device (**fig. 1**).
- When tipping the load of a dumper, the center of gravity moves and continually the condition of the ground as well as the judgement of the operator are essential for the stability of the machine.
- When the dumper is loaded by shovel, crane or other similar external methods, the driver must leave the cab (**fig. 2**).
- Perform the unloading manoeuvre gradually, maintaining the stability of the dumper. Avoid transporting materials that might stick to the dumper (for example: clayey loam) or that could get stuck in the dumper (for example: blocks of stone), as the loss of control possibly produced by the tipping maneuver places the stability of the dumper at risk.



(fig. 1)

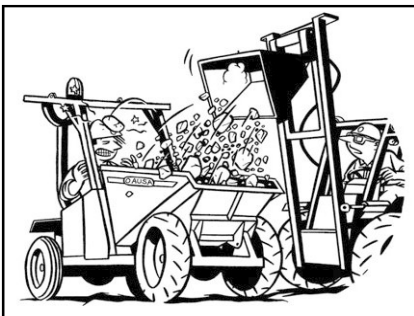

(fig. 2)

! Special safety messages

■ When leaving the vehicle....

- Turn the engine off and switch off the ignition. Place the cargo box in the horizontal resting position (**fig. 1**).
- Place all controls in the neutral standby position.
- Apply the parking brake.
- Lock all mechanisms that impede use of the dumper by unauthorised persons; the starter circuit in particular, by removing the ignition key.
- If you must leave the dumper on a slope, in addition to putting the parking brake on, immobilize the wheels with suitable chocks.
- Park the dumper in areas specifically designated for this purpose, and not in a place where it might prevent people from passing or block exits or access to stairways or emergency equipment.
- Since the dumper has an articulated chassis, always leave it parked in a straight position.

■ Good maintenance ensures safety , for that reason....

- Never stop carrying out dumper maintenance. Specialized personnel should be assigned to this job and, provided with the necessary tools and appropriate instructions.
Only authorized personnel should perform maintenance and repair work.
- Unless unavoidable, all work on the dumper should be done with the engine switched off, the skip unloaded, and all the immobilizing and locking devices engaged.
- Some operations are easier done with the skip raised. Before doing so, precautions must be taken using the safety props designed for this purpose to keep it from accidentally tipping. These props are provided with each dumper model (**fig. 2**).
- Before disconnecting fluid systems, make sure there is no pressure in them and take steps to avoid unexpected spills. Never use a naked flame to check fluid levels and leaks.
- Regular checks should be carried out on the hydraulic system to detect any possible leaks or misalignment on the safety valves that could cause a risky situation.
- Regular checks should also be carried out on all those elements that could pose a risk if they are subjected to excessive wear or aging , for example: hydraulic hoses, , tires patterns, etc.
- If the roof or operator protection frame must be replaced with a new one for safety reasons.
- All identification, instruction and warning plates attached to the dumper must be kept in a perfectly readable condition.
- Any modification that affects the capacity and safety of the dumper must be authorized by the vehicle manufacturer or by a responsible manufacturer, modifying the instruction manuals and plates where necessary as well.
- The manufacturer will not be held responsible for any incidents or accidents caused by the use of non-original spare parts or by repairs carried out by unauthorized workshops.
- When replacing tires, ensure that they are the correct replacements and follow the tire manufacturer's safety instructions. For safety reasons, split wheels must not be used (those made of two rims bolted together).
- When changing a tire, make sure that it is installed with the tread pattern facing the right way.
- The dumper should be for handling or inspection using the points on the machine designed for this purpose, as indicated in this manual, and with strong enough equipment for this purpose Since the chassis is articulated, the frames must first be joined to the belt designed for this purpose.



(fig. 1)

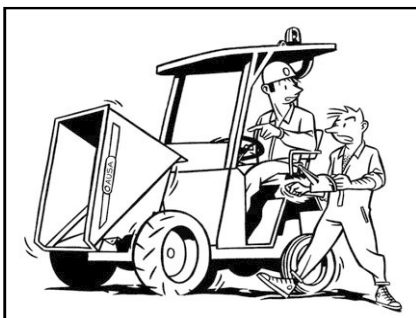

(fig. 2)



! Special safety messages

- If the dumper needs to be towed, use a tow bar whenever possible. If a tow bar is not available, use a cable that is strong enough for the job. In either case, it should be fixed onto the point indicated by the manufacturer and the manoeuvre should be carried out at a speed lower than 2 Km/h and a distance shorter than 1 Km. When driving a towed dumper, pay attention to the position of your hands on the steering wheel, to ensure that an unexpected turn of the wheel does not injure you .
- If the dumper to be towed is hydrostatically driven, before doing so, follow the instructions indicated in this manual for the disconnection of the drive shaft, therefore facilitating towing and eliminating any risk to the transmission.
- Make sure that the towing vehicle has a strong enough towing and braking capability to be able to perform this operation.
- If the dumper needs to be transported on a truck platform or any other suitable mean of transport:
 - Be sure to do so with the minimum fuel level in the tank.
 - Take into account for the transport of the dumper the requirements of the ADR regulations that may be applicable.
 - Apply the parking brake.
 - Apply chocks to the wheels and attach them to the truck bed.
 - Anchor the machine firmly to the truck bed using slings or other methods to prevent any kind of movement.
- When carrying out any repair work, make sure that the battery terminals are protected, so that they cannot be accidentally shorted out by a tool, part, etc.
- Since the chassis is articulated (articulated frame steering), before undertaking any operation on the dumper, place the joining beam between the frames so that the articulations are immobilized (**fig. 1, 2**)
- Before carrying out any welding on the dumper, remove the electric and electronic equipment in order to avoid possible damage to the installations.
- Before carrying out any work on the engine cooling system, wait for the temperature of the coolant to drop enough for the coolant reservoir cap to be removed safely.
- In order to avoid allergic reactions and other hazards affecting the skin, wear protective gloves when replenishing fuel or other fluids
- Be environmentally friendly. When changing oil, fluids, tires, batteries, etc., take the used materials to the appropriate recycling centers. When handling or disposing of mufflers that contain mineral fiber based absorbent materials, protect your skin with the appropriate gloves and clothing and take the materials to approved disposal sites for this class of materials. Similarly, at the end of the useful life of this dumper, turn it in to an authorized scrap center.
- Also, if concrete spills onto the road surface, remove it before it hardens.

■ **Recommendations for Dumpers equipped with control unit (ECU)**

- All connectors must be unplugged from control units during welding operations.
- Faulty control units and sensors must not be repaired, but rather replaced.
- The functionality of some components should be checked during some maintenance operations. Contact your authorized AUSA importer or dealer for a system check. See the **LUBRICATION AND MAINTENANCE CHART**.
- Do not disconnect the battery immediately after stopping the engine. Wait at least 2 minutes before disconnecting.

ELECTROMAGNETIC COMPATIBILITY

- If the dumper is used in areas where there are devices that are very sensitive to electromagnetic emissions, make sure that they will not be affected by this.



(fig. 1)

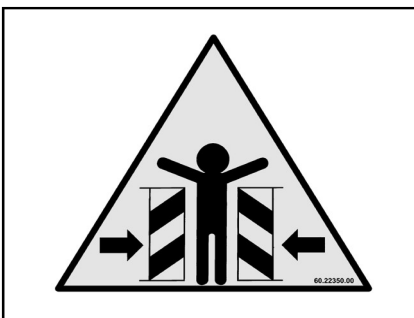

(fig. 2)

D 250 AHG / D 350 AHG / D 400 AHG / D 450 AHG



Plates and adhesives

PLATES AND DECALS	REFERENCE	QTY.	POSITION
	65.12004.00	1	<p>On the engine bonnet, in front of the joystick</p>
	01.00779.40	1	<p>On the engine bonnet, behind the operator's legs, to the left.</p>
	39.08242.01	1	<p>On the right side descendant, next to the mounting plate with the chassis.</p>
	09.12011.00	1	<p>On the engine bonnet, behind the operator's legs, to the right.</p>
	01.00757.00	1	<p>On the top of the front protector, to the right of the steering wheel.</p>
	45.19101.00	2	<p>On both engine access covers, next to the lock.</p>
	60.22350.00	2	<p>On both sides of the rear chassis, next to the articulation.</p>



Plates and adhesives

PLATES AND DECALS		REFERENCE	QTY.	POSITION	
<p>WARNING Avoid touching fan. Serious injury can result.</p>	Danger risk of injuries.	02.00766.01	1		In the engine compartment, to the left side of the radiator.
<p>WARNING Avoid hot exhaust pipe. Avoid serious burns.</p>	Danger risk of burns.	02.00764.03	1		On the engine bonnet, on the right side, next to the access covers.
<p>! Danger ! Keep clear of machine working area!</p>	Danger working area	14.00775.03	2		On both rear sides of the skip
<p>CAUTION When leaving Dumper unattended, lower the bucket to transport position, place gear and directional control levers in neutral, apply the parking brake, stop the engine, remove ignition key</p>	End of operation,	02.00773.03	1		On the skip rear face, to the left.
<p>WARNING Do not attempt to use this machine without authorization and without knowing fully how the machine works</p>	Warning authorisation and equipment usage	02.00777.00	1		On the top of the front protector, to the centre, in front of the steering wheel.
	Tie down points	09.15720.00	2		On the front chassis ears welded on the chassis.
<p>DIESEL</p>	Fuel type	43.01356.00	1		In the engine bay, right side, on the fuel tank.

D 250 AHG / D 350 AHG / D 400 AHG / D 450 AHG



Plates and adhesives

PLATES AND DECALS	REFERENCE	QTY.	POSITION	
	Hydraulic oil type	43.01352.20	1	<p>In the engine bay, left side, on the hydraulic oil tank (standard equipment).</p>
	Biodegradable hydraulic oil type.	43.01352.21	1	<p>In the engine bay, left side, on the hydraulic oil tank (standard equipment).</p>
	Engine oil type	43.01170.02	1	<p>On the inner face of the left side engine access cover.</p>
	Brake fluid specification.	55.00780.00	1	<p>On the engine bonnet, behind the operator's legs, to the left.</p>
	Operating in gradients indication and equipment loading.	09.00769.00	1	<p>On the skip rear face, to the right.</p>
	Inflation pressure 5 bar / 74 P.S.I. / 500 kPa	01.12106.01	2	<p>D 250 AHG model. On both sides of the skip, over the front wheels. D 400 AHG model. On the rear fender, over the rear wheel D 450 AHG model. On both sides of the skip, over the front wheels.</p>
	Inflation pressure 4 bar / 57 P.S.I. / 400 kPa	01.12104.01	2	<p>D250 AHG model. On the rear fender, over the rear wheel</p>



Plates and adhesives

PLATES AND DECALS		REFERENCE	QTY.	POSITION	
	Inflation pressure 4,1 bar / 59 P.S.I. / 410 kPa	01.12109.01	2		D 350 AHG model. On both sides of the skip, over the front wheels.
	Inflation pressure 2,5 bar / 36 P.S.I. / 250 kPa	01.12101.01	2		D 350 AHG / D 450 AHG models. On the rear fender, over the rear wheel
	Inflation pressure 6,5 bar / 96 P.S.I. / 650 kPa	01.12107.01	2		D 400 AHG model. On both sides of the skip, over the front wheels.
	Maximum speed 25 Km/h	46.11720.00	1		On the machine's counterweight, in the lower left corner (optional).

Specifications

Machine	Unité	D 250 AHG	D 350 AHG	D 400 AHG	D 450 AHG
Specifications and weights					
Discharge type	-	Swivel			
Payload	kg	2500	3500	4000	4500
Maximum towing mass	-	-			
Trailer without brakes	kg	750			
Trailer with brakes	kg	3500			
Chassis	-	Articulated and oscillating			
Steering angle	°	30	30	30	30
Oscillation	°	13	13	13	13
Water skip capacity	l	720	1020	1370	1370
Struck skip capacity	l	1330	1790	2055	2055
Heaped skip capacity	l	1560	2130	2670	2670
Unladen weight (std)	kg	2650	2780	2830	2970
Front axle maximum weight	kg	3325	4500	5100	5600
Rear axle maximum weight	kg	2100	2100	2100	2100
Service temperature	°C	-15 a +40			
Fuel tank capacity	l	44			
ROPS frame	-	Rear folding, According to ISO 3471			
Transmission					
Type	-	Hydrostatic			
Drive pump	-	Variable displacement axial piston pump and automatic adjustment			
Drive motor	-	Variable displacement axial piston motor and 2 speeds selectable by the operator.			
Max. service pressure	bar	420			
Forward / reverse selector	-	Electro-hydraulic by a switch under the joystick			
Front axle	-	Straight with differential and wheel epicyclic gearing			
Rear axle	-	Straight with differential and wheel epicyclic gearing			
Engine (see manufacturer instruction manual)					
Brand	-	KUBOTA			
Model	-	D2403M - E3B			
Power	kW	36.5			
Maximum engine speed	Min-1	2700			
Torque	N·m@rpm	160@1600			
N° of cylinders	-	4			
Exhaust values according to	-	StagellIA - EPA Tier4i			
Fuel consumption	l/h	7.9			
CO2 emissions ²	kg/h	21			
Cooling system	-	Water - oil radiator			
Drive					
Max. Speed	km/h	21			
Max. Speed in slow gear	km/h	7			
Grade-ability	%	70	54	49	35
Safe authorised inclination	%	¿?	¿?	¿?	¿?
Outside turning radius	%	4300	4515	4720	4830
Front tires (std)	-	10.0/75-15,3	11.5/80-15,3	11.5/80-15,3	12.0/75-18
Inflation pressures	bar	5	4,1	6,5	5
Rear tires (std)	-	10.0/75-15,3	11.5/80-15,3	11.5/80-15,3	12.0/75-18
Inflation pressures	bar	4	2,5	5	2,5
Speed and load index ⁽⁶⁾	-	A4 - 130	A5 - 141	A5 - 141	A5 - 144
Steering					
Design	-	Hydraulic power steering - Two ways acting ram			
Max. service pressure	bar	110			
Work hydraulics					
Hydraulic tank capacity	l	40			
Hydraulic pump	-	Single gear pump taking power from the hydrostatic pump			
Capacity	cc/rev	12			



Specifications

Machine	Unité	D 250 AHG	D 350 AHG	D 400 AHG	D 450 AHG
Flow rate (max. Rpm)	l/min	31,2			
Max. service pressure	bar	170			
Control valve	-	Monoblock 2 spools control valve			
Electric system					
Starter motor	Kw	2.0			
Alternator & regulator	W	700			
Battery	V-Ah-A	12-70-640			
Brakes					
Service	-	In the front wheels, Totally enclosed multiplate oil immersed discs. Hydraulically operated.			
Parking	-	In the front wheels, Totally enclosed multiplate oil immersed discs. Hand operated.			
Sound levels					
Sound power level A-weighted warranted in the environment L _{wA} ⁽¹⁾	dB(A)	98			
Sound power level A-weighted warranted in the environment L _{wA} ⁽¹⁾	dB(A)	101			
Measured uncertainty KpA ⁽²⁾	dB(A)				
Sound pressure level A-weighted at operator's position L _{pA} (without cab) ⁽³⁾	dB(A)	84			
Sound pressure level A-weighted at operator's position L _{pA} (with cab) ⁽³⁾	dB(A)	n/d			
Vibration levels					
Average acceleration value to whole body ⁽⁵⁾	m/s ²	<0,25 m/s ²			
Average acceleration value to hand ⁽⁵⁾	m/s ²	<0.5 m/s ²			

1 According to ISO 6395 (Directive 2000/14/CE)

2 According to ISO 6396

3 According to ISO 6394 (Directives CE 84/532/CEE, 89/514CEE y 95/27/CEE)

4 According to ISO ISO 7096 (Directive 2000/44/CE)

5 According to ISO 2631 / ISO 5349-2 (Directive 2000/44/CE)

6 Tires with a combination of different loads index and speed rates than those indicated, can give equivalent results in terms of load and speed conditions required for each vehicle according to the specifications of load variation with speed reduction established by the E.T.R.T.O. technical manual.

Specifications

■ Optional equipment

Los equipamientos opcionales están señalados con las siguientes notas: (opcional) - (de equiparse). Los equipamientos opcionales sólo se suministran bajo petición expresa del cliente, para determinadas versiones de máquina o bien para países concretos.

- ROPS/FOPS closed cab with heater
- Certified light equipment
- Emergency stop
- Full Visibility System
- Waterproof case to store manuals
- Tow hitch with caliper (Rockinger type)
- Electric take-off for towing (Obligatory lighting system)
- Rear body reflective safety stickers
- Front rubber mudguard
- Non-standard paint colour
- Spare wheel
- Maintenance kit (1000 h)
- Austrian circulation regulation (model D 350 AHG)
- GERMAN circulation regulation
- Swiss circulation regulation

Consultar otros implementos y accesorios disponibles con garantía de fábrica.



Specifications

Machine measurements

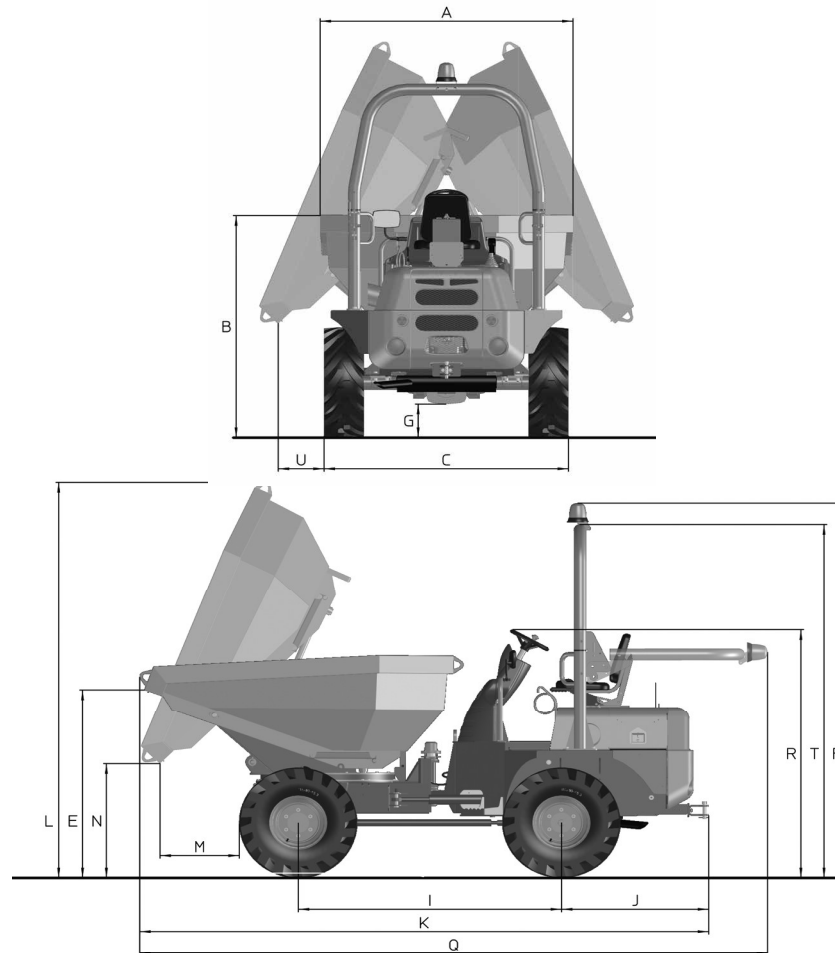

Dimensions (mm)	D 250 AHG	D 350 AHG	D 400 AHG	D 450 AHG
A	1503	1852	1866	1866
B	1694	1730	1838	1838
C	1770	1845	1845	1865
E	1380	1435	1620	1635
F	2905	2930	2935	2935
G	230	255	260	260
I	1960	1960	1960	1960
J	1040	1040	1040	1040
K	4035	4180	4385	4390
L	3080	3085	3150	3150
M	565	565	805	770
N	970	920	712	735
O	-	-	-	-
P	-	-	-	-
Q	4465	4605	4820	4820
R	1909	1930	1935	1935
S	-	-	-	-
T	2740	2765	2765	2765
U	285	320	525	515

How to identify the Dumper



(fig. 1)

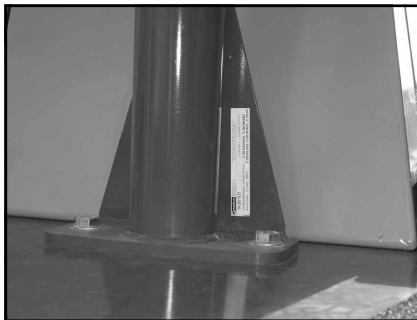

(fig. 2)

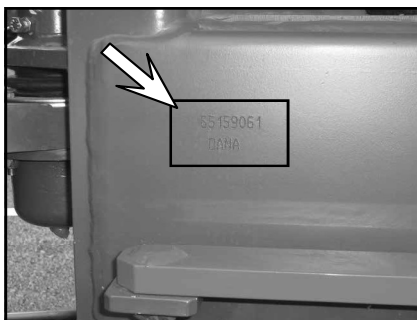

(fig. 3)

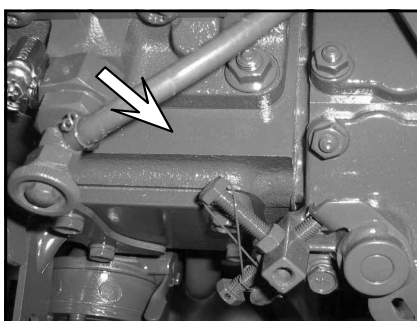

(fig. 4)

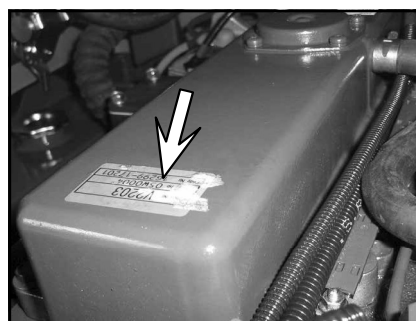

(fig. 5)

NOTE

Please indicate model number, date of purchase and frame and serial number when consulting AUSA or your authorized AUSA importer or dealer for any matter. This information can be found on the identification plate. We recommend you make a record of these numbers in the spaces provided below for handy reference and keep this in your files.

Dumper model:

Date of purchase:

Frame number:

Engine number:

■ **The machine identification plate (fig. 1)**

Is located on the front of the engine bonnet, behind the operator's legs, to the left. It features the CE trademark. Included the CE trademark.

■ **The roll over protection structure (ROPS) homologation plate (fig. 2)**

On the right side descendant, next to the mounting plate with the chassis.

■ **The chassis number (fig. 3)**

Is marked on the front part of the right side of the chassis.

■ **The engine number (fig. 4, 5)**

It is marked in the block in the left side after the fuel filter and in an etiquette in the top part of the lid of balance beams.

■ **Identification plates of the main components**

Identification plates for all components not manufactured by AUSA, such as engines, pumps, etc. are attached to the components themselves, in the positions where they were originally fitted by the respective manufacturers.



Controls Instruments Equipments

■ Terms right, left, front and rear, used in this manual indicate the sides of the dumper per from the driver's seat looking forward.

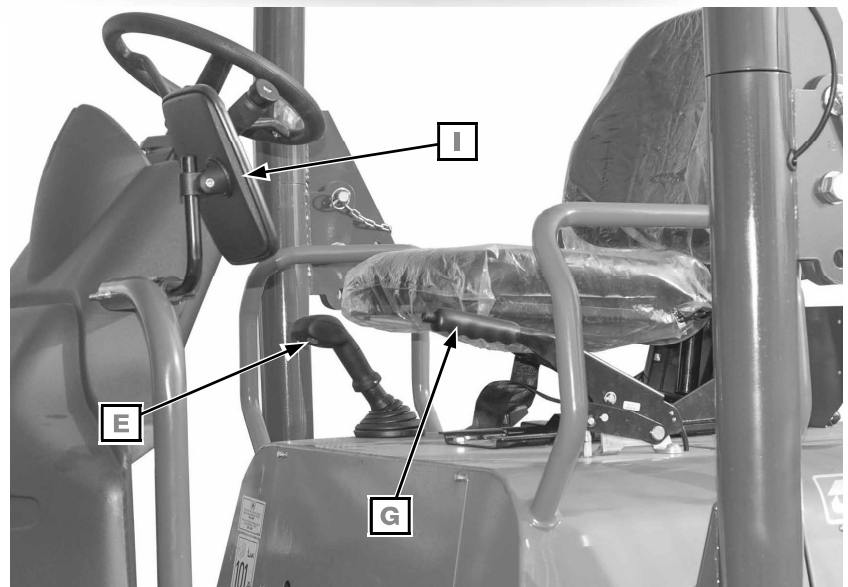
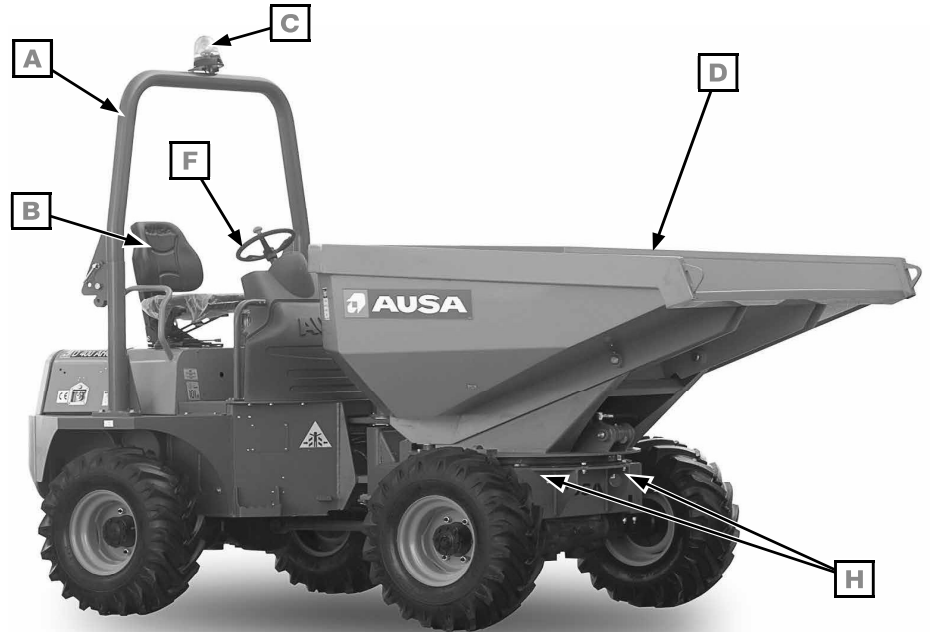

■ Identification components

- A- Roll over protection structure (ROPS).
- B- Operator's seat with seatbelt.
- C- Rotating beacon.
- D- Skip.
- E- Joystick.
- F- Steering wheel.
- G- Parking brake
- H- Lighting (if equipped)
- I- Rear view mirror (if equipped)

Controls Instruments Equipments

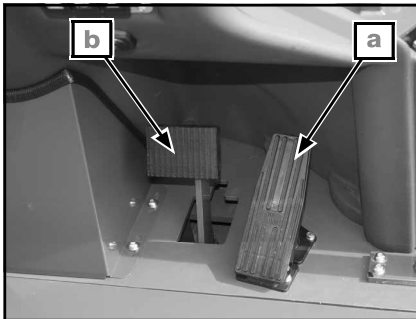

(fig. 1)

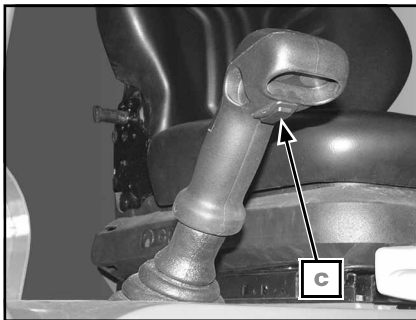

(fig. 2)



(fig. 3)

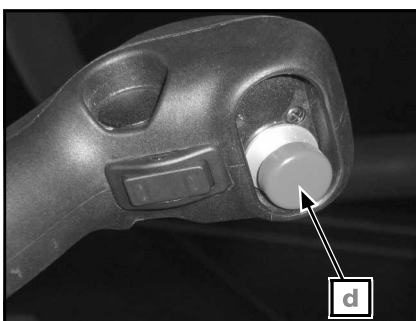

(fig. 4)

■ Pedals (fig. 1)

- a- Throttle pedal
- b- Foot brake pedal

■ Joystick (fig. 2)

The joystick, located to the driver's right, controls the movements of the skip and the driving direction of the dumper.

■ FNR switch (fig. 2)

The FNR switch is operated with the electric switch (c) located underneath the joystick handle. When the direction arrows are not lit, the driving FNR switch is in the NEUTRAL position. Pushing the front of the switch will cause the machine to move forward and pushing the back of the switch will cause, the machine to move in reverse. In each case the corresponding directional arrow will turn on, green (forward) or red (reverse).

■ Back-up alarm

This sounds when selecting reverse gear.



WARNING



If the dumper is equipped with lighting, the back-up alarm is disconnected when the lights are switched on. However, the rear white reversing lights continue working. An operator's choice on-off system can be assembled as an option (fig. 3).

■ Speed control (fig. 4)

Transmission fast/slow speed can be selected by pushing switch (d).

NOTE

The dumper control panel does not display the selected drive speed.



Controls Instruments Equipments

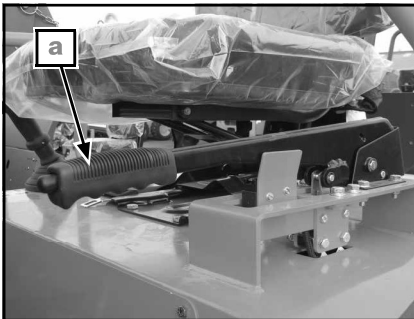

(fig. 1)

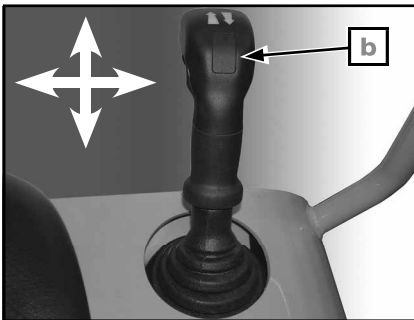

(fig. 2)

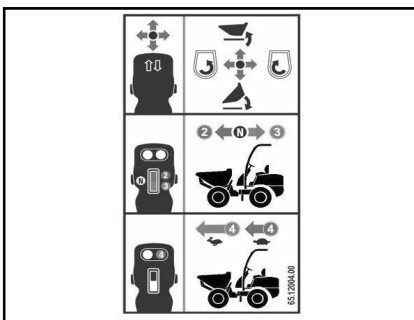

(fig. 3)

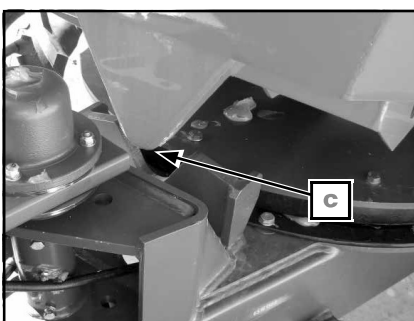

(fig. 4)

■ Parking brake (fig. 1)

Parking brake is activated by lever **(a)** and wire with blocking system located at the left side of the driver's seat.

Put the lever in the up position until the wheels are blocked.

To release the parking brake pull down the lever by pushing the button on the front of the lever and move it to the resting position.

NOTE

Equipped with a device which disconnects the transmission with the hand brake on.

■ Emergency brake

In case of emergency, use parking brake.

■ Control for handling the skip (joystick) (fig. 2, 3, 4)

Hopper operation is done with the joystick

Pushing the joystick forwards **(b)** tips the skip for unloading and pulling it backwards moves the skip back down to the resting position

The skip swivels towards the left or the right depending on whether the joystick is moved towards the driver or towards the right

Before operating the joystick, it must be raised enough to clear the turn lock **(c)**.

Also when lowering the skip, keep in mind to center it as much as possible so that it fits in the turn lock.

Controls Instruments Equipments

■ Control panel and controls

These are located on the front operator protector and on the joystick.

1- Ignition switch (fig. 1).

Located on the right side of the front operator protector.

a- Stop

b- Ignition & cold start system

c- Start-up

Insert the key in the ignition switch and turn it to the **(b)** position until the cold start system lamp goes out.

Press the throttle pedal $\frac{1}{4}$ of the stroke and turn the key to the **(b)** position. Do not maintain this position for more than 15 seconds. If the engine fails to start repeat the previous steps. Wait 30 seconds between each try.

CAUTION

In cold temperatures, slowly increase the diesel engine revolutions to achieve good lubrication of the engine.

Switches. (fig. 2).

D- Rotating beacon

Two positions switch:

0.- Rotating beacon OFF

1.- Rotating beacon ON

The switch indicator lights will illuminate

E- Horn

Two positions push switch

F- Hazard lights (only dumpers with lighting).

Two positions switch:

0.- Hazard lights OFF

1.- Hazard lights ON

The switch indicator light will blink as well as the indicator lamp **(I)** (fig. 3).

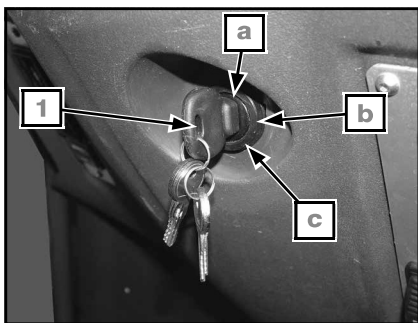

(fig. 1)

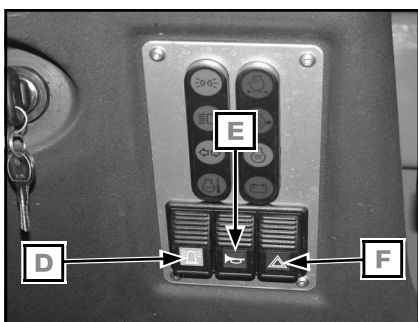

(fig. 2)

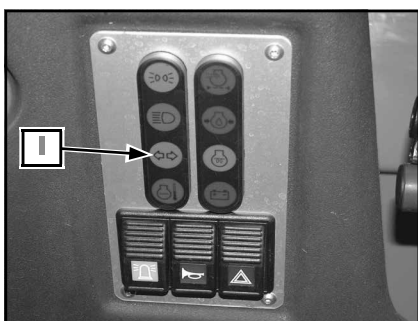

(fig. 3)



Controls Instruments Equipments

Lamps. (fig. 1)

Located on the right side of the front operator protector.

NOTE

See **PERIODIC MAINTENANCE OPERATIONS** in this manual to solve the problem or contact with an authorised AUSA importer or Dealer for a system check.

G- Position lights lamp / low beam lamp (only dumpers with lighting).

It is illuminated when we select this type of system of illumination.

H- High beam indicator lamp (only with lights option).

Turns on when selecting this type of lighting via the multifunction switch.

I- Turning indicators lamp (only dumpers with lighting).

This lamp flashes indicating a change in direction with the turning indicators.

J- Engine temperature lamp.

When this lamp glows it means that the engine is operating at high temperature which could damage the engine. The engine should be stopped immediately to determine the cause of the high temperature. It might be due to a low level of cooling, dirt in the radiator or that the thermostat does not work correctly, break of the alternator belt or pump water.

K- Air filter clogged lamp.

When the air filter becomes clogged with dirt, this lamp will light. The air filter should be immediately cleaned or serviced.

L- Engine oil pressure warning lamp.

When this lamp is lit means that the engine oil level is low causing low oil pressure to the engine. The engine should be stopped immediately to prevent engine damage. Add oil to the engine until the proper level is reached.

M- Cold start lamp.

When this lamp turns on, indicates that the engine cold start system is working. Wait until the lamp will turn off before starting the engine.

N- Charge battery lamp.

This gauge shows the condition of the battery and will tell you if the battery charge is too low or if the alternator is not charging properly. Once the engine starts to run, this red lamp will go out. If it remains lit, stop the engine and determine the cause.

O- Fuse box. (fig. 2).

Located on the left side of the front operator protector.

See the **PERIODIC MAINTENANCE OPERATION** in this manual to identify the number and function of each fuse.

P- Hourmeter. (fig. 2).

This is located underneath the fuse box. The hour meter registers the time that the engine has been running. This allows to control the maintenance periods.

See the **LUBRICATION AND MAINTENANCE CHART** section in this manual.

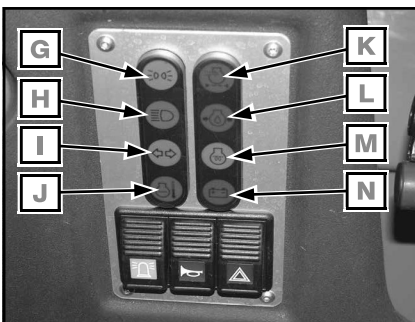

(fig. 1)

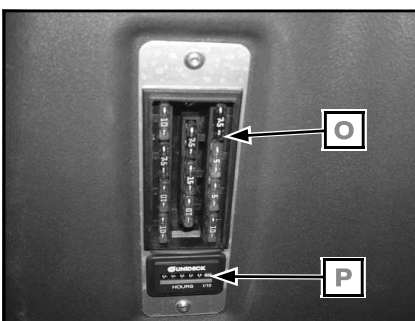

(fig. 2)

Controls Instruments Equipments

■ Multifunction switch (fig. 1, 2)

Located on the steering column.

Directional indicators.

By pulling the lever **(a)** from its neutral point towards the driver, the left directional indicator is selected; and by pushing the lever to the front, the right directional indicators are selected. When the warning light **(I)** (fig. 3) flashes in the control panel and dashboard.

Sidelights / dipped headlights / full- beam headlights / flashes.

Rotating the lever **(a)** to the first position the sidelights are connected. Turning it to the second position, the dipped headlights are connected. Pushing the lever downwards, the full-beam lights are connected. Pulling the lever upwards selects the headlights passing lights.

Horn.

It is activated by pressing the end of the multifunction switch.

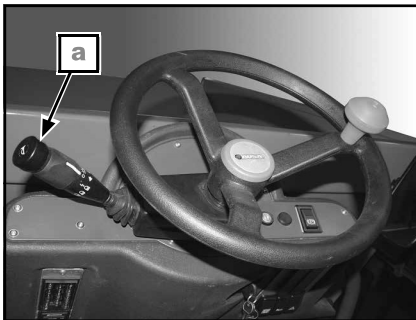

(fig. 1)



(fig. 2)

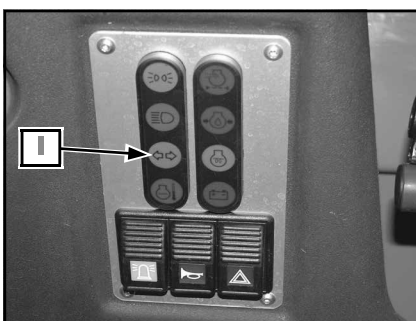

(fig. 3)



Controls Instruments Equipments

■ Full Visibility System (FVS) (if equipped)

1.- Target and components location

The obstacle detection system together with the display system (FVS) is intended to prevent the risk of collision due to the presence of objects or others in the vicinity of the machine.

The system consists of two vision cameras, a display screen and eight obstacle sensors.

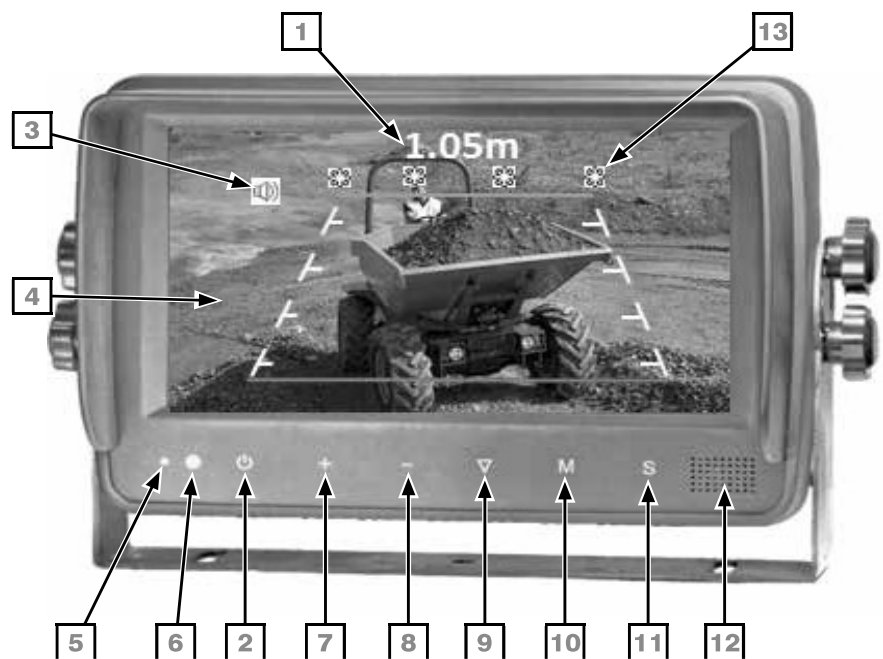

1. Distance from obstacle.
Front of machine: Distance between the front wheels and the obstacle.
Rear of machine: Distance between the machine rear end and the obstacle.
2. Power switch / Power indicator.
3. Voice guidance.
4. Digital colour LCD screen.
5. Light level sensor.
6. Remote control sensor.
7. Brightness increase.
8. Brightness decrease.
9. Setting selection down / grid lines display.
10. Menu.
11. CAM1/CAM2/CAM3 Selector.
12. Embedded speaker.
13. Sensors indicators.

Controls Instruments Equipments

- a. Front obstacle sensors (**fig. 1**).
- b. External speakers (**fig. 2**).
- c. Rear obstacle sensor (**fig. 3**).
- d. Front vision camera (**fig. 4**).
- e. Rear vision camera (**fig. 5**).

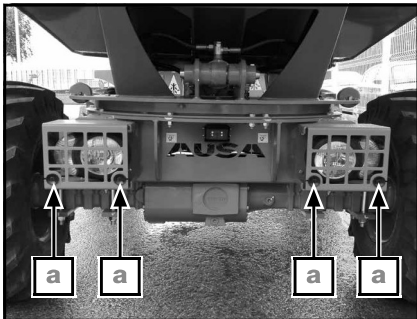

(fig. 1)

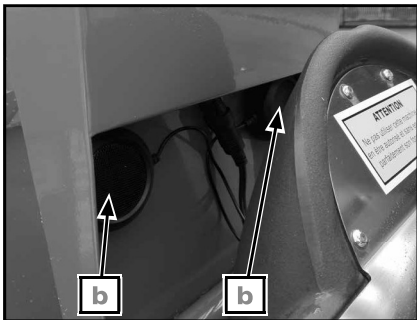

(fig. 2)

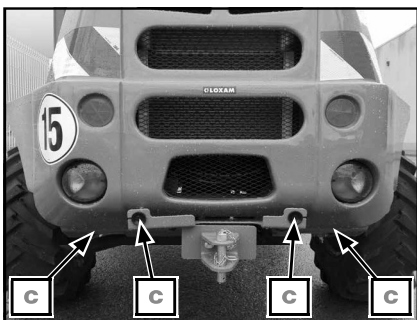

(fig. 3)

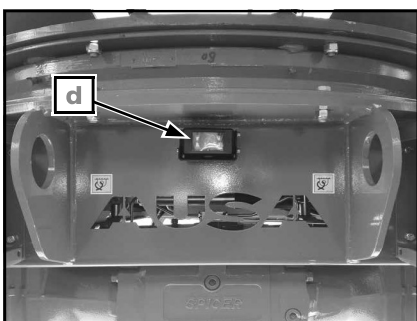

(fig. 4)

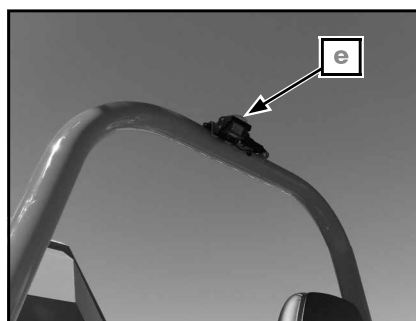

(fig. 5)



**Controls
Instruments
Equipments**

2.- Model system reach (D 350 AHG)

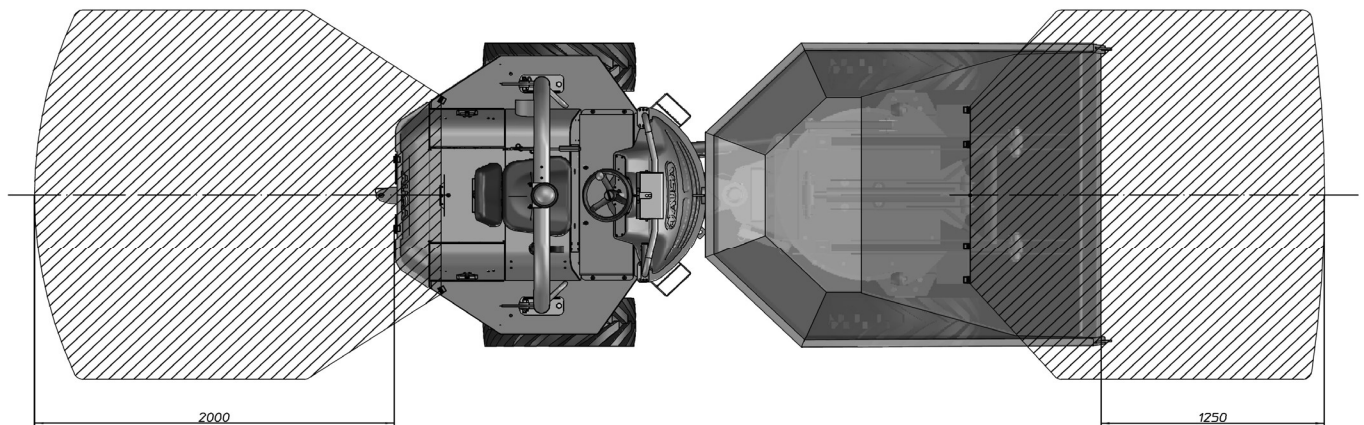
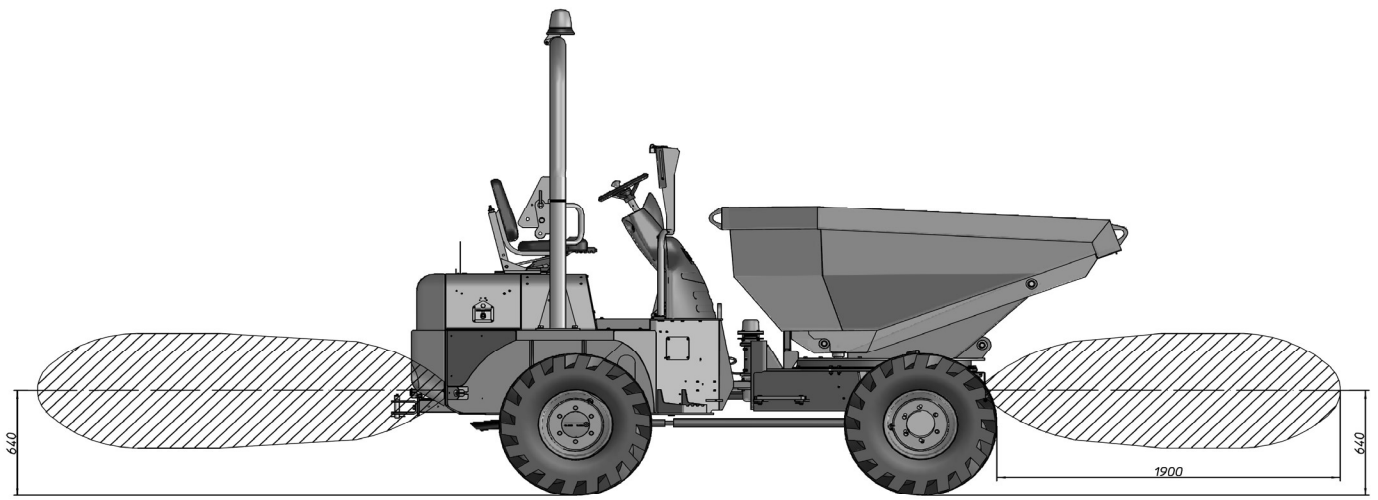

Controls Instruments Equipments

3.- System description

Display system (fig. 1, 2, 3, 4)

The display system switches on automatically when:

- turning the key **(1)** to ignition position **(b)**.
- selecting forward or reverse using the FNR switch placed underneath the joystick **(d)**.
- the handbrake is off **(e)**.

When the system is enabled, the power switch turns on with a green light, in the lower corner of the screen **(3)**.

Since the display and the obstacle sensor systems are interconnected, the display screen must be turned on to make it operational.

The display system can be switched off by the operator's choice by pressing the same display power switch only with the FNR switch underneath the joystick is placed in the NEUTRAL position and/or the handbrake on.

In this case, the power switch turns on with a red light.

Obstacle detection system

The four front sensors start to detect when the forward drive is selected using the switch placed underneath the joystick.

Likewise, the four rear sensors are activated when the reverse drive is selected.

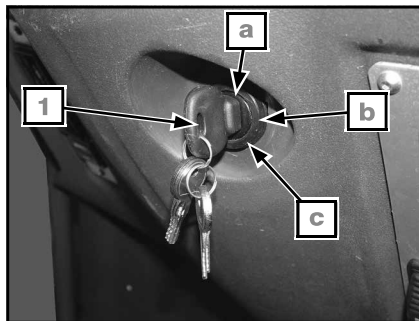

(fig. 1)

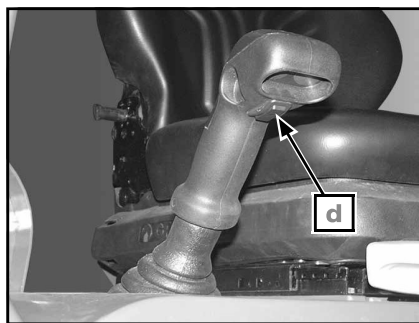

(fig. 2)

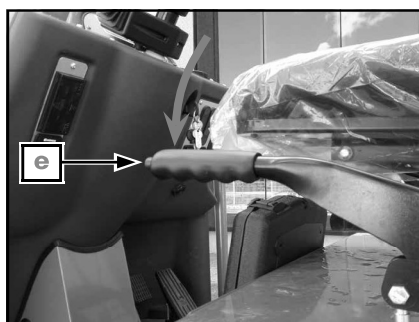

(fig. 3)

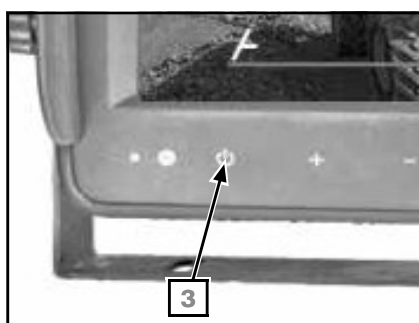

(fig. 4)

NOTE

With the FNR switch underneath the joystick is placed in the NEUTRAL position, the system remains in the same operating conditions left during the last selection.

That is, if the last selection in the NEUTRAL position was with the display powered off, it would switch off after some seconds.

If the last selection in the NEUTRAL position was with the rear camera, the same camera selection would appear in the display.



Controls Instruments Equipments

Joint system operation (fig. 1)

With the obstacle detection enabled, the display screen shows the image of the vision camera together with the asterisk shape indicator **(13)** of the four sensors currently active.

An obstacle detection is reported by the flashing of the corresponding asterisk accompanied by a variable frequency audible signal indicating the obstacle distance with faster tones and flashes indicating closer proximity and a continuous tone indicating a minimal pre-defined distance.

The distance in metres between the sensor and the obstacle is displayed on the screen, which is:

- Front of machine: distance between the front wheels and the obstacle
- Rear of machine: distance between the rear end of the machine and the obstacle

Moreover, a voice assistant warns about the distance between the sensor and the obstacle as well.

NOTE

The voice assistant is always in English language.
Regardless of the language selected in the OPTIONS menu.

NOTE

The system would not detect thin or low objects; sound absorption materials, such as snow, cotton or rubber foam, and objects located just below the counterweight.

Guidance grid display (fig. 2, 3)

Front and rear cameras view offers the display of a guidance grid **(b)** in the screen.

To display the guidance grid, click ▾ **(10)** in the lower corner of the screen

NOTE

The guidance grid may not correspond to reality due to the position of the camera and its lens.
Likewise, objects in the camera's focus may appear closer or further than they appear.

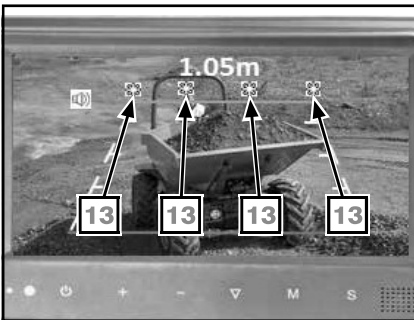

(fig. 1)

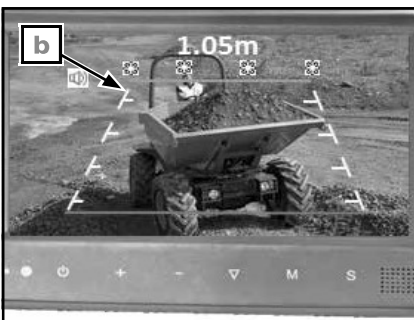

(fig. 2)

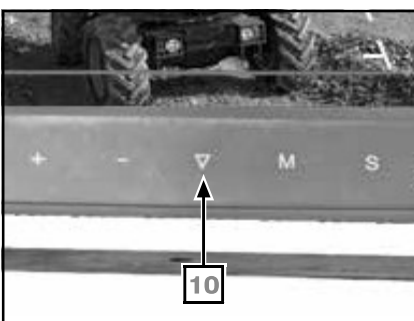

(fig. 3)

Controls Instruments Equipments

Cameras selection (fig. 1, 2, 3, 4)

CAM1 is the one that appears by default when selecting the front drive.
CAM2 is the one that appears by default when selecting the reverse drive.
La CAM3 has no function.

With the FNR switch underneath the joystick is placed in the NEUTRAL position, any camera can be selected by pressing "S" (12) in the lower corner of the screen.

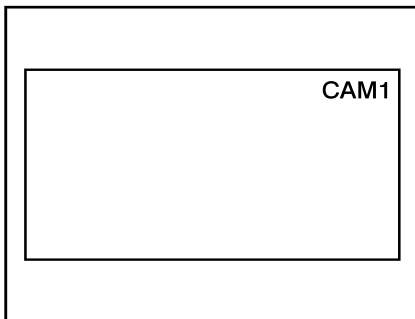

(fig. 1)

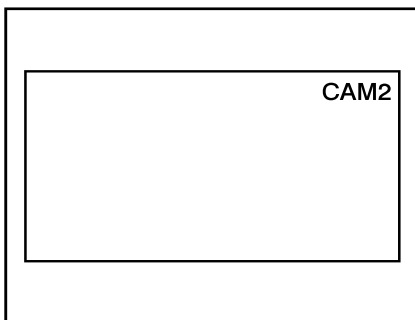

(fig. 2)

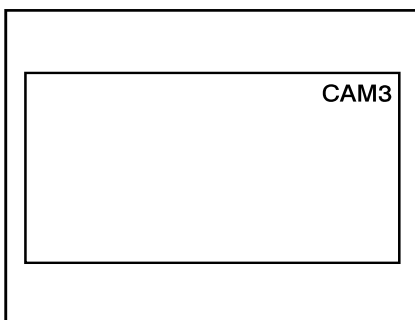

(fig. 3)

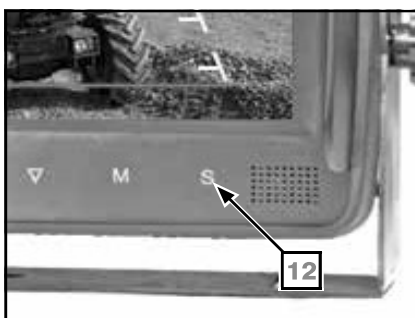

(fig. 4)



Controls Instruments Equipments

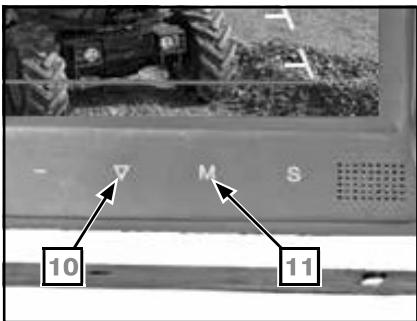

(fig. 1)

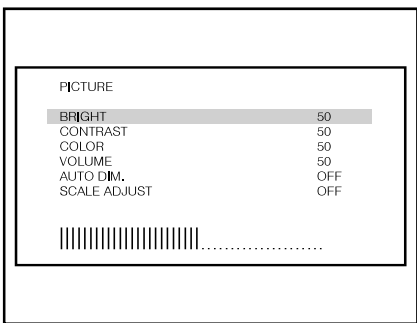

(fig. 2)

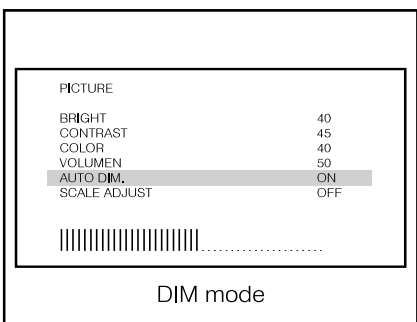

(fig. 3)

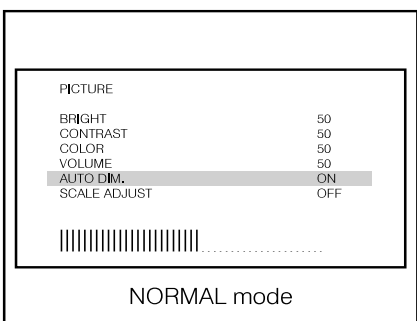

(fig. 4)

Menu (fig. 1)

Press "M" (menu) **(11)** to display the following options and settings:

1. PICTURE
2. OPTIONS
3. SYSTEM
4. AUTO SCAN

1. Picture

- BRIGHT, CONTRAST, COLOR, VOLUME, AUTO DIM and SCALE ADJUST options will display on the screen **(fig. 2)**.
 - Press ∇ **(10)** to select BRIGHT.
 - Press + / - to adjust brightness level.
- When AUTO DIM is turned on **(fig. 3, 4)**:
 - In a dark environment: OSD turns into dim mode for dim setting.
 - In a bright environment: OSD display in normal mode
- Press ∇ **(10)** to select SCALE ADJUST
 - Press + / - to select $\downarrow\uparrow$ or $\rightarrow\leftarrow$ to guidance grid adjustment $\rightarrow\leftarrow$ **(fig. 5)**.
- Exit menu and press again ∇ **(10)** to display guidance grid.
 - If $\downarrow\uparrow$ is selected, press + / - to adjust the grid scale up / down;
 - If $\rightarrow\leftarrow$ is selected, press + / - to adjust grid scale left / right **(fig. 6)**.

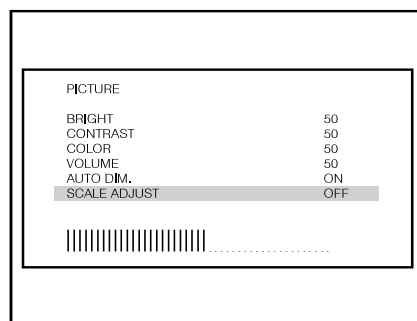

(fig. 5)

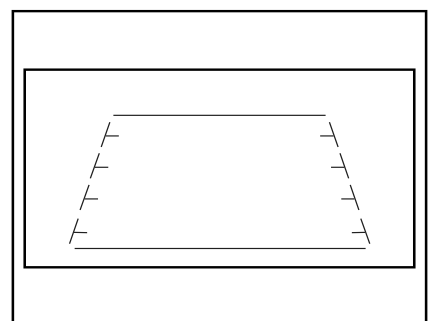

(fig. 6)

Controls Instruments Equipments

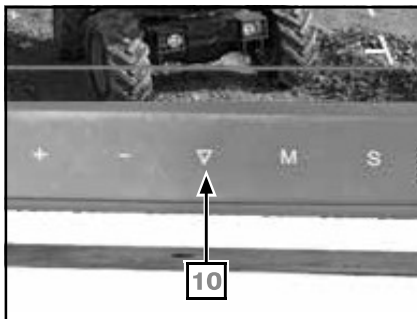

(fig. 1)

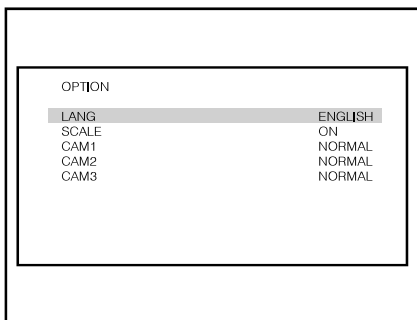

(fig. 2)

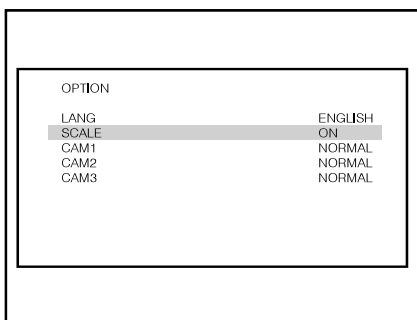

(fig. 3)

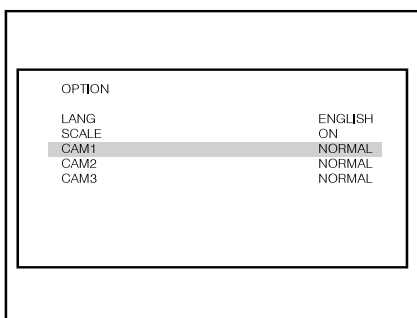

(fig. 4)

2. Option

- LANG, SCALE, CAM1, CAM2, CAM3 options will display on the screen
 - Press ▾ (10) to select LANG (fig. 1);
Press + / - to select English, Deutsch, Français, Español, Português, Italiano, Nederlands or РУССКИЙ options (fig. 2).
 - Press ▾ (10) to select SCALE
Press + / - to select ON / OFF. Scale refers to the guidance grid displayed on the monitor (fig. 3).
 - Press ▾ (10) to select CAM1, CAM2 o CAM3.
Press + / - to select NORMAL / MIRROR (fig. 4).



Controls Instruments Equipments

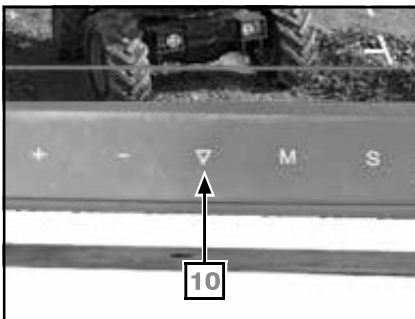

(fig. 1)

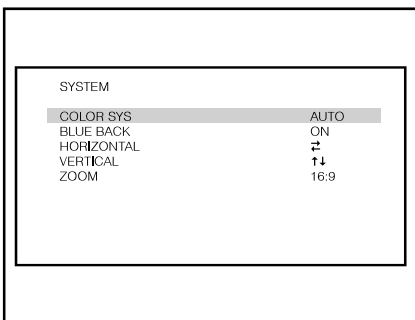

(fig. 2)

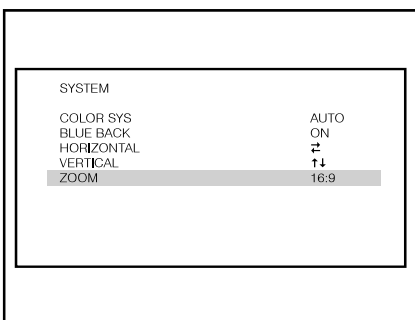

(fig. 3)

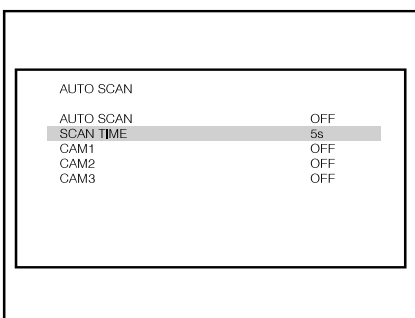

(fig. 4)

3. System

- COLOR-SYS, BLUE BACK, HORIZONTAL, VERTICAL, ZOOM functions will display on the screen
 - Press ▾ (10) to select COLOR-SYS (fig. 1).
Press + / - to select AUTO / PAL / NTSC (fig. 2).
 - Press ▾ (10) to select ZOOM
Press + / - to select 4:3 (fig. 3).

4. Auto scan

- AUTO SCAN, SCAN TIME, CAM1, CAM2, CAM3 functions will display on the screen
 - Press ▾ (10) to select SCAN TIME
Press + / - to select 1s a 90s (fig. 4).

■ Using accessories and equipment

If the dumper is equipped with accessories, prior to using them, read carefully the Instruction manual specific for the accessory provided by its manufacturer and enclosed in this main dumper manual. If the accessories and equipment are to be mounted on the dumper basic chassis, by external suppliers (sub-suppliers), you must consider all the dumper prescriptions and limitations in regard to mass and dimension, effectiveness of the light system and its fitting, as well as the need of protections to additional systems so as to guarantee the dumper safety.

Operating the dumper



WARNING



Before each period of use, check that the dumper brakes, hydraulic controls, instruments, safety equipment and the driving direction control (FNR) are functioning properly.

A machine that operates correctly is more efficient and could prevent accidents. Carry out all necessary adjustments or repairs before operating the dumper.

■ Entering and exiting the operator's cab.

Do not grab and pull the steering wheel when entering the operator's cab, hold the handles provided for this purpose and always place your foot on the step in order to avoid slipping both when entering and exiting the cab.

■ Adjust the seat (fig. 1, 2)

Each day, before operating the dumper, adjust your seat to a position in which you feel comfortable.

Pull the lever **(a)** to the right to unlock the seat. Slide the seat forward or backwards to reach the desired position. Releasing the lever will cause the seat to lock.

According to the weight of the driver, set the seat with the lever **(b)**. There are 24 turns of the lever from minimum driver weight of 60 kg. to maximum 120 kg.

Normally it is adjusted for a driver weighting 90 kg.

Ensure that you fasten your seatbelt.

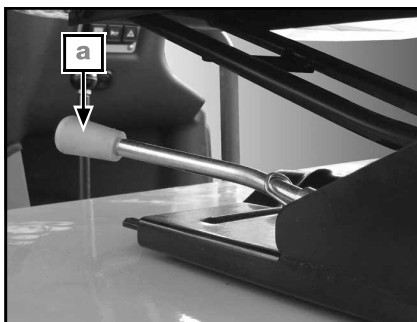

(fig. 1)

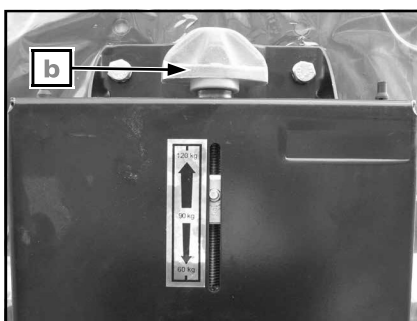

(fig. 2)



Operating the dumper

■ Seatbelt

To fasten the seatbelt, insert the anchor point **(a) (fig. 1)** into the buckle **(b) (fig. 2)** until you hear the locking "click".

To unfasten the seatbelt, press button **(c) (fig. 3)**.

The seat belt must adapt to the body of the passenger who's using it, thus providing him/her with autonomy of movement, while adjusting the belt to the physical complexion of the driver.



WARNING



The safety seat belt is an important part of the safety system and must always be fastened before starting work with the sweeper. If the belt is not fastened, in case of overturning you may suffer serious injury or even death by crushing, caused by the sweeper or the protective roof itself.

See annex for instructions of accessories or special finishes (if equipped).

■ Checking

With the engine running and the dumper stopped, carry out the checks and tests indicated in the **PRE-OPERATION CHECK** section of this manual.



(fig. 1)

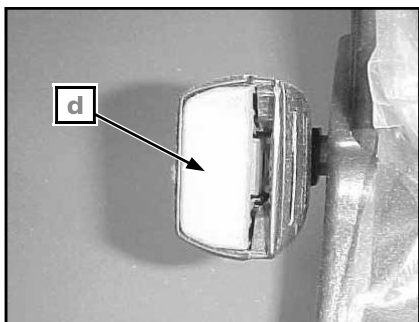

(fig. 2)

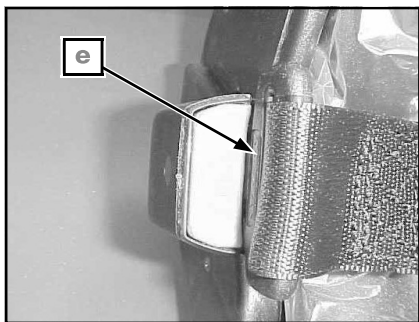

(fig. 3)

Operating the dumper

■ Load capacity (see dumper identification plate)

The nominal load is the load the dumper can safely transport, it is determined by the weight of the load.

The use of attachments or accessories may reduce the load capacity.

The condition of the ground and the load method may affect safety conditions.

Overloading the skip makes the dumper unstable and, hard to handle and may cause the dumper to tip over or some of the components to break.



DANGER



Handling, stability and braking distance are affected when the dumper is loaded. Correct loading and weight distribution are important. Never, overload, tow or pull a load improperly. Always ensure that the load is supported and adequately distributed before operating the dumper. Drive at slow speed and in accordance with the ground conditions when transporting a load or towing a trailer.

Remember that a greater braking distance is required. Always place the load as low as possible in order to reduce the effects of a high center of gravity. Failure to follow these recommendations could change to the handling of the dumper possibly causing an accident occurring, which could mean serious injury or even death for the operator.

■ Loading the dumper

When charging vehicle, respect these maximum loads.

- D 250 AHG: Maximum load capacity 2500 Kg.
- D 350 AHG: Maximum load capacity 3500 Kg.
- D 400 AHG: Maximum load capacity 4000 Kg.
- D 450 AHG: Maximum load capacity 4500 Kg.



WARNING



Overloading can make it impossible to rise the skip.

■ The relationship between the dumper and the load is altered by changes in:

- The use of attachments or accessories.
- Changes in the motion of the dumper and the grade of the ground on which it is moving.
- Smoothness and stability must be maintained while these factors change constantly during dumper operation.

This requires careful judgement on the part of the operator.



Operating the dumper

Starting and stopping the engine

Starter (fig. 1)

For safety reasons when starting the dumper, the operator must be seated and with the seatbelt fastened, the park brake must be applied and also be sure to check that the gear lever and the drive direction control switch (FNR) **(d)** are in the NEUTRAL position. Insert the key into the ignition switch and turn it to position **(b)** until the cold start lamp turns off, press the throttle pedal a 1/4 of the way and turn the key to position **(c)** until the engine starts. Do not hold this position for more than 15 seconds. If the engine does not start repeat the previous operations. Wait for 30 seconds between each try.

NOTE

This dumper has a starter lock. Take into account that the driving direction switch **(d)** must be in the NEUTRAL position.

CAUTION

In cold temperatures, slowly increase the engine revolutions to achieve good lubrication of the engine.

Jump starting the machine

If the engine cannot start due to a dead battery, another 12V booster battery can be used together with the corresponding jump leads to connect the two batteries. If you use the battery of another machine or dumper, do not allow the two machines to touch.

- 1- Apply the parking brake.
- 2- Open the floor plate access cover. See the section **PERIODIC MAINTENANCE OPERATIONS** in this manual.
- 3- Connect the (+) positive terminal of the battery with the (+) terminal of the dumper and use the other to cable connect the (-) negative terminal with the (-) of the dumper.
- 4- Start the dumper in the usual way.
- 5- Disconnect the cables from the terminals, starting with the (+) positive terminals and then moving to the (-) negative terminals.

Parking the dumper and stopping the engine

Whenever the dumper is parked, either at the end of the day or in order to carry out any maintenance work, it should be parked on level ground. Apply the dumper's parking brake. Keep the engine in idle for 1 minute, if the dumper has been working at full load. Then turn the ignition key counterclockwise, to stop the engine. Chocking the wheels with suitable blocks is also recommended. Remove the key from the ignition and take it with you. Never leave the key in the parked dumper.

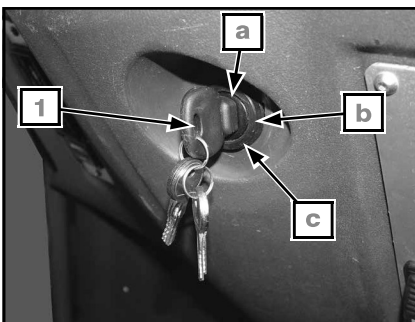

(fig. 1)

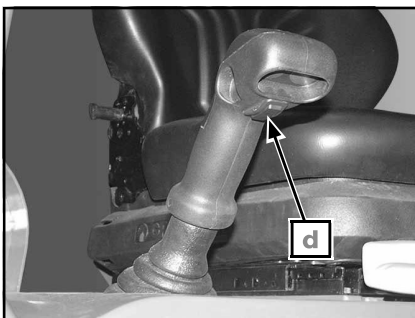

(fig. 2)

Operating the dumper

■ Folding ROPS Frame Operating Procedure (fig. 1, 2, 3, 4)

The folding ROPS comprised of two sections (h) and (i) and is pivoted to approximately half of its length allowing it to be tilted towards the rear of the machine thus reducing the transportation height of the machine, but not the working height.

NOTE

There are 2 gas struts which compensate the weight of the top half of the roll over protection structure (ROPS) (h) during the procedure.

Travelling position



WARNING



Do not work with the machine if the ROPS frame is in the Travelling position.

To place the roll over protections structure (ROPS) in this position follow the instructions below:

- 1- Remove the two locks (j) from the bolt pins (k) located on both sides of the roll over protection structure (ROPS).
- 2- Remove the bolt pins (k).
- 3- Carefully pull the top half of the roll over protection structure (ROPS) (h) backwards lowering into the travelling position.
- 4- Once it is correctly positioned (fig. 4), replace the bolt pins (k) and fix in place using the locks (j).

Working position

To return the roll over protection structure (ROPS) frame to its working position reverse the above procedure.



WARNING



Be careful to ensure that you arrange your feet on the machine or on the floor in a stable position to ensure that you do not lose your balance while folding back the roll over protection structure (ROPS). Similarly, take care to not place your hands around the roll over protection structure (ROPS) fold area (fig. 5) since this could cause serious injury.



(fig. 5)

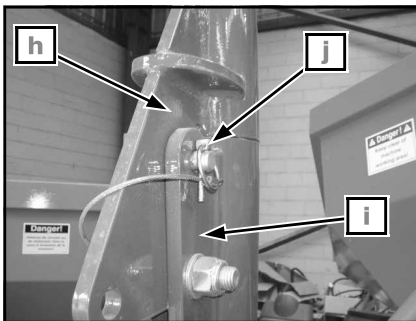

(fig. 1)

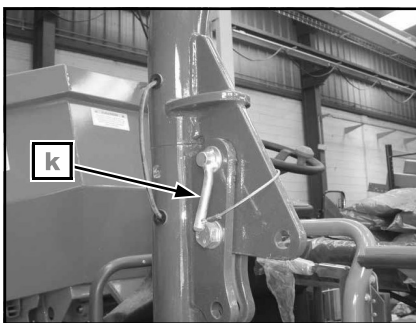

(fig. 2)

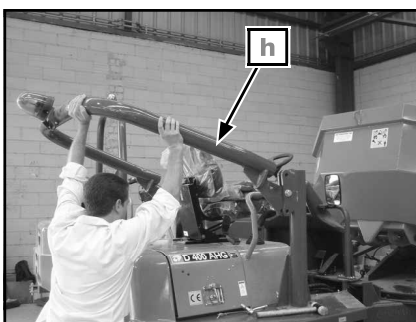

(fig. 3)



(fig. 4)

46



D 250 AHG / D 350 AHG / D 400 AHG / D 450 AHG

Break-in period

■ Engine

The engine in this dumper requires a break in period of 50 hours before operating at full load.

CAUTION

This dumper has a 4-stroke engine. Oil must be added to the engine base only. During this period, maximum throttle should not exceed 3/4 of the pedal movement.

Brief full acceleration and speed variations contribute to good break in. Continued wide open throttle accelerations, prolonged cruising speeds and engine overheating are detrimental during the break in period.

■ 50-Hour Inspection

As with any precision part of a mechanical element, we suggest that you have the dumper inspected by an authorized AUSA importer or dealer 50 hours or 30 days purchase, whichever is reached first. This inspection will give you the opportunity to discuss unanswered questions you may have encountered during the first hours of operations.

Before starting the dumper



WARNING



These checkings are essential before putting in functioning the dumper. Always check the proper operation of controls, safety systems and mechanical components before starting. If not done as specified here, severe injury or death might occur.

- Check tire pressure and condition.
- Familiarize yourself with the controls and ensure that they operate correctly.
- Verify that the steering operates freely.
- Press the throttle pedal various times to ensure it operates freely. It must return to the original position when released.
- Press the brake pedal to ensure that the brakes operate correctly. The pedal must return to the original position when released.
- Ensure that the drive direction control (FNR) and the gear lever operate correctly.
- Check fuel, engine oil, hydraulic oil, coolant and brake fluid levels.
- Check for oil leaks in the engine, in the transmission components or in the hydraulic circuit.
- Clean the lights and the lamps (if equipped).
- Ensure that the engine is correctly covered with its bonnet.
- Ensure that the seatbelt are correctly secured.
Before starting the day, carefully inspect this device with special attention to:
 - Cuts or cracking on the belt.
 - Wear or damage to anchor points.
 - Poor functionality of the seat belt buckle or the retracting roller.
 - Loose threads or poor stitching.
- If transporting cargo, respect the maximum load capacity. Ensure that the cargo is properly distributed.
- Check the engine parts while it is stopped. Check fixtures.
- Check that the ignition switch, the headlights, the turn signal, taillights, reverse alarm (if equipped) and reverse lights are operating correctly.
- Start the engine and drive forward a short distance very slowly and press the brake pedal to check the brakes.

**Correct any problem you may have found before operating the dumper.
Consult an authorized AUSA importer or dealer if necessary.**



Transporting the dumper

■ Securing/immobilising the dumper on the truck bed (fig. 1, 2)

When transporting the dumper on a trailer or truck bed, carefully follow the instructions in the Caution Decal.



WARNING



Before lifting the dumper onto a trailer or truck bed, make certain that the ramp is strong enough to support the weight of the dumper and that the truck bed surface is free from debris, oil, grease or ice.

- Do not transport the dumper with full fuel tank. Be sure to do so with the fuel level in the tank to the minimum.

Take into account for the transport of the dumper the ADR Regulation requirements that may be applicable, according to UN No. 3528.

- Make certain your seat belt is properly fastened.
- Move the dumper up or down the loading ramps slowly and carefully
- Apply the parking brake.
- Connect the gear lever in such a way that it creates additional hold for the dumper in case the parking brake fail.
- Stop the engine and remove the key from the ignition.
- Apply chocks to the front and rear wheels.
- Firmly tie down the dumper to the truck bed or low loader with chains, cables or slings at the points provided to prevent any movement.
 - FRONT AXIS: by the ears welded on the chassis (**fig. 2**).
 - BACK AXIS: over the back wheels.
- Consider that the securing systems should be adequate and sufficiently strong for this purpose.

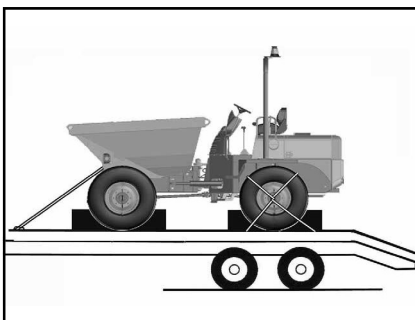

(fig. 1)

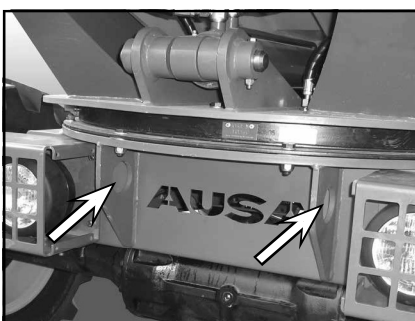

(fig. 2)

Transporting the dumper

■ Loading the dumper onto a trailer by crane (fig. 1, 2, 3, 4)

When the dumper is loaded onto a truck using a crane and a cable or sling:

- Before lifting, immobilize both parts of the chassis using the link bar provided for this purpose (**fig. 1**).
- Hook the cable or sling on the points provided for this purpose on the machine.
 - FRONT PART: by the lugs welded on the front of the skip (**fig. 2**).
 - REAR PART: by the counterweight (**fig. 3**).
- Always carry out this operation with the machine unloaded.
- Before lifting check that the cable or sling is firmly hooked and that both the crane and the cable or sling has sufficient capacity to lift the load.
- While lifting do not allow any person to be on the truck or any spectators within a 5 m. radius.
- Always undertake this operation on flat and horizontal ground.
- Use guide ropes or other systems to keep the machine from pivoting or turning.

Also consider the following recommendations.

- The slings must be long enough to form an angle wider than 45° with the horizontal.
- Always lift the machine in the most horizontal position possible.



(fig. 1)

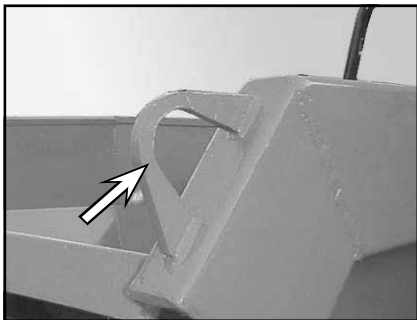

(fig. 2)

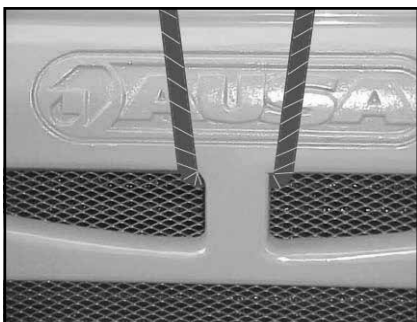

(fig. 3)

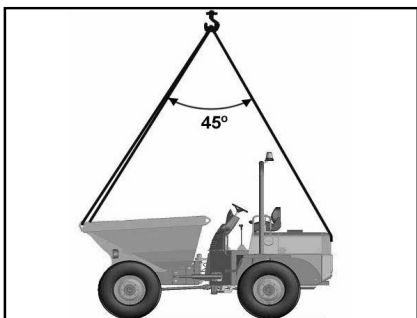

(fig. 4)



Transporting the dumper

■ Towing the dumper (fig. 1, 2)

Towing dumpers is only recommended in cases of breakdown when there is no other alternative. Whenever possible, it is recommended to repair the dumper where it is stopped. Otherwise, the towing must only be done slowly and over short distances.

Towing speed:

Drive slow and carefully without exceeding the speed of 2 Km/h

Towing distance:

Drive slow and carefully without exceeding a towing distance of 1 Km

- If there is no oil pumping, the hydraulic circuit drains itself.
- Pay attention to the generation of heat of the hydrostatic group.

CAUTION

Risk of damage!

High towing speeds and long towing distances result in impermissible heat generation and insufficient lubrication. These factors will damage the axial piston unit.

During and after towing, the hydrostatic group units are hot.

- Wear the appropriate protective equipment.



WARNING



Do not tow this dumper behind a car or another machine.



(fig. 1)



(fig. 2)

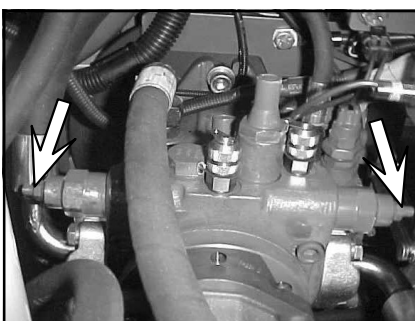

(fig. 3)

When driving, the country regulations relating to the towing of an off-road machines on roads and highways must be complied with.

The dumper must be towed using a solid towbar to avoid any sideways oscillation, and always with both parts of the chassis immobilized by using the link bar provided for this purpose (fig. 1).

Attach the towbar to the counterweight rear pin (fig. 2).

Brake unit release

Release the parking brake.

Hydrostatic group by-pass (fig. 3)

- 1- Remove the floor plate to access to the hydrostatic pump. See article **PERIODIC MAINTENANCE OPERATIONS**.
- 2- To open the by-pass valves, loosen the lock nuts of the central screws by using a 13 mm. hexagonal wrench.
- 3- Insert a 4 mm. Allen wrench to screw in the screw clockwise until the screw is against the spring seat. **DO NOT INCREASE THE RESISTANCE. JUST TOUCH THE SPRING SEAT.**
- 4- Once are against the spring seat, screw the screw two turns (without exceeding).

Once the machine is fixed, loosen the central screws counter-clockwise to the stop and tighten the lock nuts.



D 250 AHG / D 350 AHG / D 400 AHG / D 450 AHG



Fluids and lubricants

This section specifies the recommended liquid and lubricants. See the “MAINTENANCE CHART” on this manual for the recommended change / service intervals.			
FLUID OR LUBRICANT	SPECIFICATION	REMARKS	CAPACITY (litres)
FUEL	Use clean auto diesel (class A), preferably in accordance with Directive 98/70/EEC modified by directive 2003/17 or Standard EN 590 equivalent to the same.	See FUEL on this section	44
ENGINE OIL	Oil for engines classification API CF of better, with a high Total Base Number (TBN) of a minimum 10.	See section ENGINE OIL in this section	7.6
ENGINE COOLANT	Ethylene glycol antifreeze with corrosion inhibitors for aluminum engines with internal combustion, 40% glycol / 60% distilled water in Standard machine.	See section ENGINE COOLANT in this section	7.5
HYDRAULIC CIRCUIT (standard)	Hydraulic oil ISO Grade VG-46 in accordance with ISO 6743/4-HV DIN-51524 Part 3 HVLP	See HYDRAULIC CIRCUIT in this section	40
HYDRAULIC CIRCUIT (optional)	Synthetic and biodegradable hydraulic oil HLP-46	See HYDRAULIC CIRCUIT in this section	40
DIFFERENTIAL FRONT AXLE OIL	SAE 85W/90 API GL4 MIL L-2105 With additives for oil-bathed brakes.		4,1
FRONT AXLE WHEEL HUB REDUCTION OIL			0,35
REAR AXLE AND TRANSFER BOX			4,7
REAR AXLE WHEEL HUB REDUCTION OIL			0,35
BRAKE FLUID	Mineral brake fluid LHM (green) in accordance with ISO VG32.	See BRAKE FLUID in this section	1
BATTERY ELECTROLYTE	Distilled Water	See section BATTERY ELECTROLYTE in this section	-
GREASING POINTS	Calcic grease NLGI-3 consistency	See section LUBRICATION POINTS in this Operator's manual	-



Fluids and lubricants

■ Fuel

Use automotive clean diesel. In principle, the use of REM type bio-diesel or similar is not recommended. In case of use, the proportion used should not exceed 5% of the fuel mix. Diesel Fuel Specification Type and Sulphur Content % (ppm) use, must be compliant with all applicable emission regulations for the area in which the engine is operated. Use of diesel fuel with sulphur content less than 0.10 % (1000 ppm) is strongly recommended.

If high-sulphur fuel (sulphur content 0.50 % (5000 ppm) to 1.0 % (10000 ppm)) is used as a diesel fuel, change the engine oil and oil filter at shorter intervals. (approximately half). DO NOT USE Fuels that have sulphur content greater than 1.0 % (10000 ppm).

■ Engine oil

Always check the oil container label to ensure that the oil meets the required specifications. Your machine leaves the factory with SAE 20W40 viscosity. However, and in accordance to the climate, refer to the following chart (**fig. 1**) to select the proper viscosity.

CAUTION

If you use oils of different brands, empty completely the housing before adding the new oil.

■ Engine coolant

Cooling system must be filled with distilled water and antifreeze solution:

- 40% antifreeze, 60% water in standard machine for temperatures of 1.4 °F up to 260.6 °F (-17 °C up to 127 °C).
- 50% antifreeze, 50% water in standard machine for temperatures of -31 °F up to 293 °F (-35 °C up to 145 °C).

■ Hydraulic Circuit

Standard

- VG 32 to room temperature below 50 °F (10 °C)
- VG 46 for room temperatures to 50 °F up to 104 °F (10 °C up to 40 °C)
- VG 68 for room temperature above to 104 °F (40 °C)

Optional (**fig. 2**)

- HLP 32 to room temperature below 50 °F (10 °C)
- HLP 46 for room temperatures to 50 °F up to 104 °F (10 °C up to 40 °C)
- HLP 68 for room temperature above to 104 °F (40 °C)

■ Brake fluid

Liquid brakes type (green) LHM of mineral base according to ISO VG32.

CAUTION

To avoid serious damage to the braking system, do not use fluids other than the recommended one, nor mix different fluids for topping up. Under no concept use liquid of brakes of vegetable base (SAE J1703).

■ Battery electrolyte

This dumper is equipped with a type battery that requires maintenance. Add distilled water for missing electrolyte.

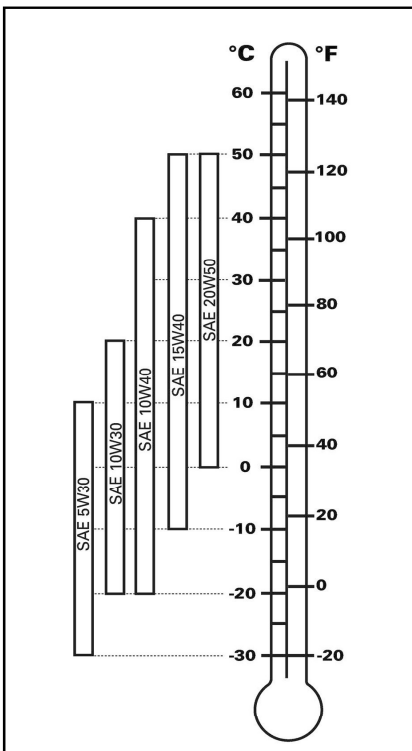

(fig. 1)

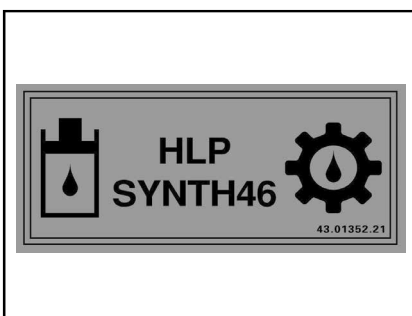

(fig. 2)

Special procedures

1.- Engine Overheat

If the engine overheats and the temperature warning light on the right side of the operator protector turns on, try the following:

Check and clean the radiator fins. See the **PERIODIC MAINTENANCE OPERATIONS** section of this manual.



WARNING



The radiator can get very hot, wear gloves before touching the radiator.

Reduce the machine speed but try to keep the dumper moving to supply air to the radiator.

If the engine is still overheating after approximately 1 minute, stop the dumper and place the gear lever or the drive direction control switch (FNR) in the NEUTRAL position, apply the parking brake and stop the engine.

Allow the engine to cool down. Check the coolant level and refill if necessary.

If the engine continues overheated, consult an authorized AUSA importer or dealer as soon as possible.

2.- Post-operation care

When the dumper is used in areas near salt water areas (beach areas, etc.), rinse with clean water to preserve the dumper and its components from corrosion.

Lubrication of metallic parts is highly recommended.

This must be performed at the end of each operation day.

When the dumper is operated in muddy conditions, it is recommended that you rinse the dumper to preserve the dumper and its components.

CAUTION

Never use high pressure water to clean the dumper **ONLY USE LOW PRESSURE WATER.**

High pressure water can cause electrical and mechanical damage.



Special procedures

3.- Overturning

In the event that the dumper overturns: it is important that the driver avoids being trapped between the machine and the ground. To prevent this we recommend:

- Try to remain within the operator cab.
- Grasp the steering wheel firmly.
- Push feet firmly against the floor plate of the cab.
- Try to keep as far away from the point of impact as possible.

If the dumper is overturned or stays tilted on one side, put the machine in its normal operating position (on all four wheels).



WARNING



DO NOT TRY TO START UP THE DUMPER without first speaking with an authorized AUSA importer or dealer.

- Disassemble pre-heating spark plugs.
- Turn the key of the starter to the position **(c)** (**fig. 1**). Keep the key in this position until the oil has gone out of the combustion chambers.



DANGER



The oil will come out at high pressure and this could cause injuries.

- Mount the pre-heating spark plugs again.
- Check engine oil level and refill if necessary.
If the pressure indicator is on after starting the engine, turn it off straightaway in order to avoid internal damage and consult an authorized AUSA importer or dealer, who will find out the cause.

4.- Dumper immersion

Should the dumper become submerged, it will be necessary to take it to an authorized AUSA importer or dealer as soon as possible.



WARNING



DO NOT START THE ENGINE. Submersion of the dumper can cause serious damage if the correct start-up procedures are not followed before starting the engine.

Consult an authorized AUSA importer or dealer to fully inspect the fuel system as stated in the **LUBRICATION AND MAINTENANCE CHART**.

5.- Storage and preseason preparation

When a dumper is out of use for more than one month, must be stored properly. When using the dumper after storage, preparation is required. Consult an authorized AUSA importer or dealer for the correct start up procedure.

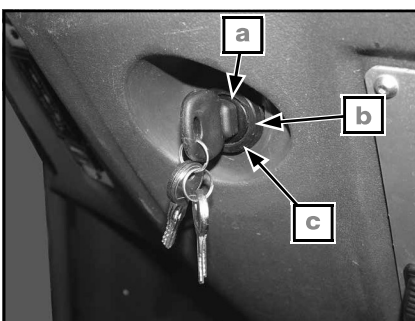

(fig. 1)

Periodic maintenance operations

■ **Use only original AUSA spare parts for maintenance operations. This is the only way to guarantee that your dumper will remain as technically efficient as when it was purchased.**

■ This dumper just like any other, parts and systems which are subject to wear and misalignment, which may affect reliability and driver safety, the environment and the area, exhaust emissions, etc.

Necessary maintenance must be carried out periodically to ensure that the machine is kept in a condition similar to when it left the factory.

In accordance with Work Group Directives, inspections of these systems must be carried out periodically and the results recorded on the forms provided by the Work Authorities of each country. (89/655/CEE and RD1215/97).

Unless work on the engine demands that it be running, perform all repairs and maintenance on the dumper with the machine parked and unloaded, with the gear stick in NEUTRAL or the drive direction control switch in the NEUTRAL position and with the wheels blocked to keep the dumper from moving during servicing.

Unless otherwise specified, do not start the engine during maintenance operations.

Disconnect the battery before carrying out any operations on the electrical system with the disconnecter (**fig. 1**). Open the floor plate to access to the disconnecter. See the disassembly procedure on the next page.

Never use a flame to check fluid levels.

■ **Be environmentally friendly**

When changing oils or other fluids, use an appropriate container to collect the fluid and ensure that you are not harming the environment during the operations and take all replaced materials (batteries, coolant, tires, etc.) to the appropriate recycling centres.

In cases of leaks of substances which could be harmful to people or the environment, urgently take the necessary actions to reduce the impact, e.g. in oil leaks, plug the leak, place a container underneath to collect the oil, spread absorbent material or dig up and remove the contaminated ground if necessary.

■ **Washing the dumper**

During the washing process, care must be taken to avoid aiming the pressurized water jet at the air intake (air filter), battery, control panel, alternator and other electrical equipment since this can damage the components.

■ **Roadside breakdown**

In the case of a breakdown when driving on a road, you must use the warning triangles.

NOTE

The provision of these signaling triangles is the responsibility of the operator.



(fig. 1)



Periodic maintenance operations

■ Access for maintenance (fig. 1, 2, 3)

The engine, the transmission and the filters are located underneath the engine bonnet, at the rear of the machine (fig. 1), under the maintenance access plate, placed perpendicular to the operator's seat (fig. 2) and underneath the floor plate (fig. 2). To access them, we must proceed as it follows:

- a- Engine cover**
- b- Floor plate**
- c- Engine cover lock**
- d- Engine cover support rod**

To lift the side covers, lift the lock and turn it to the right (fig. 3).

Lift the cover (right or left) pulling it. There are rods (d) to maintain it in the upper position. To gain access to the floor plate and the front chassis access cover, loose the fixation screws and remove the cover.

In addition, there are a openings in the front right of the chassis (fig. 4). This cover help the access to the fuel filter for the replacement operation.

- e- Front chassis access cover**

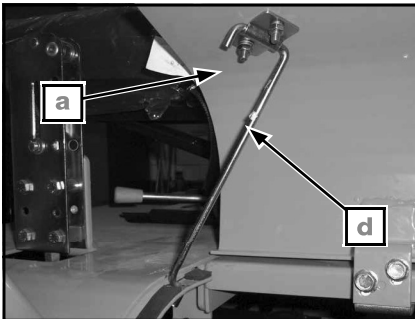

(fig. 1)

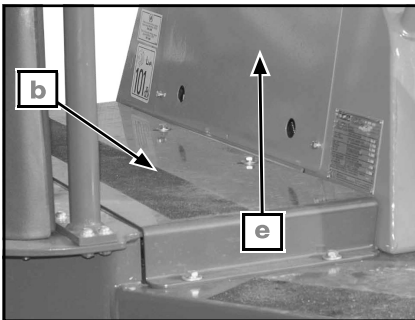

(fig. 2)

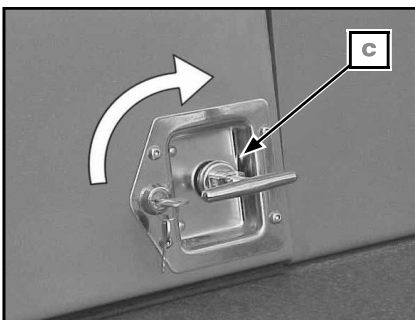

(fig. 3)



(fig. 4)

Periodic maintenance operations

■ Safety prop to avoid the descent of the skip (fig. 1)

There is a prop to avoid the raised skip from descending when maintenance operations are being carried out. This ensures that your manipulation under the skip is completely safety.

g-Raised skip safety prop

■ Chassis articulation safety prop (fig. 2)

Before carrying out any intervention that requires you to be located between the two parts of the chassis, immobilize the articulation with the link bar provided for this purpose.

h-Chassis articulation link bar



WARNING



Should removal of a fixing device (brackets, cable ties, etc.) be required for disassembly / assembly, always replace it a new one.

Initial maintenance is very important and must not be neglected. See the **LUBRICATION AND MAINTENANCE CHART** in this manual. The maintenance of some of the components can be carried out by the clients if they wish to do so.

Other operations must be carried out by an authorized AUSA importer or dealer.

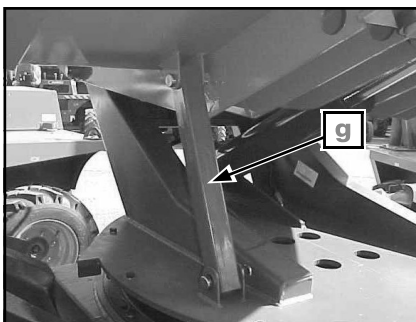

(fig. 1)

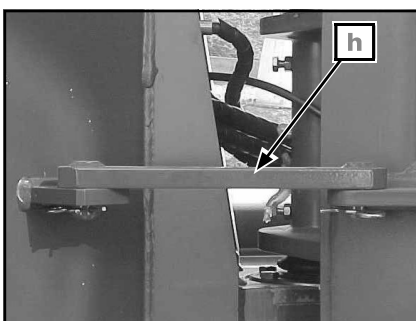

(fig. 2)



Periodic maintenance operations

1.- Engine

For operation instructions, a list of spare parts and general maintenance information consult the engine manual or the **LUBRICATION AND MAINTENANCE CHART**.

■ Generator belt

Control periodically the tension of the alternator strap. Also, verify if there are cracks or other damages. See an authorized AUSA importer or dealer to replace the generator belt.

Fan belt tension



WARNING



To avoid personal injury:

- Be sure to stop the engine and remove the ignition key before checking belts condition,
Be sure to reinstall all components already removed after maintenance or checking.

Proper fan belt tension is when a deflection of between 7 and 9 mm, when the belt is under a load of 6 to 7 kgf in the middle of the span.

1. Stop the engine and remove the ignition key.
2. Apply moderate thumb pressure to the belt between the pulleys.
3. If the tension is incorrect, loosen the alternator mounting bolts and, using a lever placed between the alternator and the engine block, pull the alternator out until belt falls within acceptable limits.
4. Replace the belt if damaged.

CAUTION

If the belt is loosen or damaged, it could result in overheats or insufficient charging. Correct or replace belt.

2.- Supply circuit.

CAUTION

Never mix oil with fuel. This vehicle has a 4-stroke engine. Oil must be added to the engine base only.

See **FLUIDS AND LUBRICANTS** in this manual for fuel specifications.

The current regulations of exhaust emissions, require that, for the whole life of the machine, the level on the different components of these emissions, are under the maximum figures stated on the regulations.

As a consequence of that, the maintenance plan of the engine has to be followed carefully, giving special attention to the quality and pureness of the fuel, the cleanness of the filters and, in general, to the general maintenance of the fuel circuit

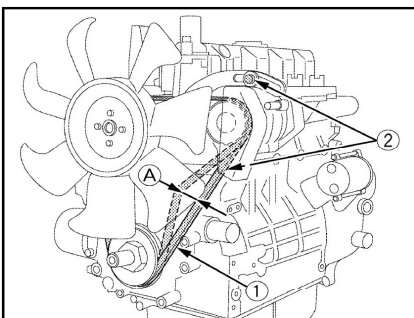

(fig. 1)

Periodic maintenance operations

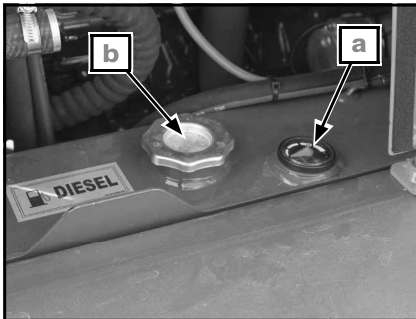

(fig. 1)

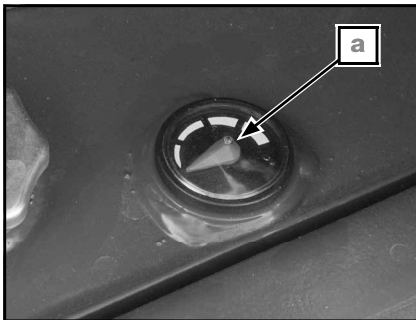

(fig. 2)

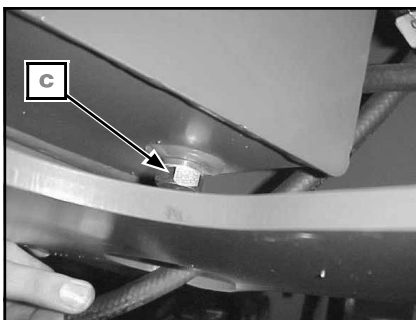

(fig. 3)

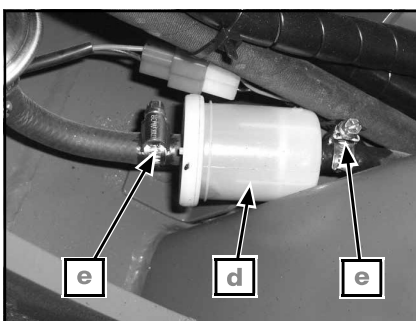

(fig. 4)

■ Fuel level (fig. 1, 2)

The fuel tank is located on the right side of the engine compartment. There is an indicator dial that shows the approximate amount of fuel in the tank.

- a- Fuel level indicator dial**
- b- Fuel filling cap**



WARNING



Always stop the engine before refuelling. Open the cap slowly. If you notice internal pressure (whistling sound heard when removing the fuel tank cap) the dumper must be inspected and/or repaired before further operation. Fuel is flammable and explosive under certain conditions. Never use a flame to check fuel levels. Never smoke, light a flame or sparks in the vicinity of the fuel tank. Always work in well ventilated areas. Never top up the fuel tank before placing the vehicle in a hot area. When temperature increases, fuel expands. If the fuel tank is completely full it may overflow. Always clean any fuel or oil spillage from the dumper.

■ Draining the fuel tank

c- Fuel tank drainage cap (fig. 2)

Draining fuel is done via the cap situated on the lower part of the tank.

- Clean the area around the fuel drain plug.
- Place a collecting receptacle underneath the oil drain plug.
- Unscrew the plug.
- Change the seal in the fuel drain plug. Clean the tank seal area and the oil drain plug and re-assemble it.

Ensure that there are no leaks from the fuel drain plug.



ENVIRONMENTAL PROTECTION



Clean any fuel spillage.

■ Change fuel pre-filter (fig. 3)

NOTE

Always replace this component. Never try to clean it.

Accede to the back inferior part of dumper under the counterweight of the engine as.

- d- Pre-filter**
- e- Flanges**

Disassemble the fixation bridles and the filter. Make sure that the new filter is mounted in the correct sense as indicates the arrow marked in the body of the filter.



Periodic maintenance operations

■ Change fuel filter

Unscrew the fuel filter located in the right side under the sheet.

NOTE

In order to facilitate the fuel filter replacement, it exists an oppening in the front left side of the chassis with an access cover. See ACCESS FOR MAINTENANCE at the beginning of this chapter.

f- Fuel filter (fig. 1)

Clean the base and grease with clean oil the joint of the new filter. Screw the filter element and tighten it without using mechanical means.



ENVIRONMENTAL PROTECTION



- Clean any fuel spillage.
- Dispose of the used oil filter cartridge in an authorized centre for this purpose..

- Start engine and let idle for a few minutes.
- Ensure fuel filter area are not leaking.
- Stop engine.

CAUTION

Take care to correctly loosen the fuel filter otherwise the fuel system could take in air causing engine failure.

■ Purge of the circuit of nourishment

If the circuit of nourishment has taken air, it is not necessary to drain the circuit, since it has a system that gives out the air within the circuit.

CAUTION

Precaution must be taken to tighten correctly the drainage **(g)** otherwise it could causing failures in the engine.

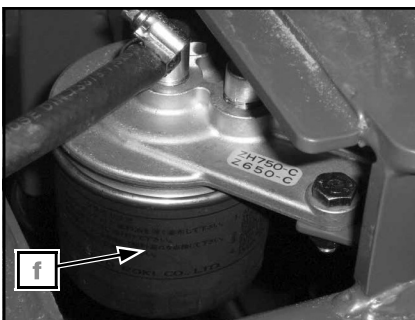

(fig. 1)

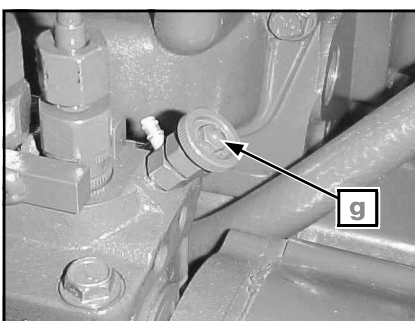

(fig. 2)

Periodic maintenance operations

3.- Engine oil.

■ Engine Oil Level (fig. 1, 2, 3)

For the oil specifications, see **FLUIDS AND LUBRICANTS** in this manual.

CAUTION

Check the level and refill frequently if necessary. Do not exceed the maximum level. Operating the engine with an inappropriate oil level could severely damage the engine.



ENVIRONMENTAL PROTECTION



Clean any spillage.

With the dumper on a level surface and the engine stopped and cold, check the oil level in the following way.

a- Dipstick

- Pull out the oil level dipstick located to the left side of the engine, remove it from its housing and clean it with a clean cloth (**fig. 1**).
- Place the dipstick in its housing.
- Remove it once again from the housing and check the oil level. It must be up to or equal to the upper level mark. (**fig. 2**)

b-Full

c- Add

d-Operating range

- Add oil up to the upper level mark if required.
- To add oil, remove the oil level dipstick. Place a funnel in the oil filling hole located on the left part of the engine.

e-Filling hole (fig. 3)

Do not exceed the maximum level.

- Properly cover the oil filling hole and correctly store the oil level dipstick.

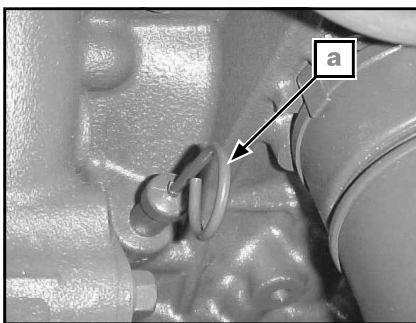

(fig. 1)

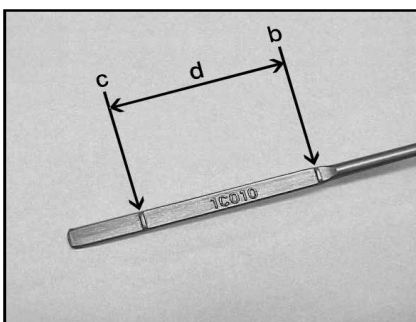

(fig. 2)

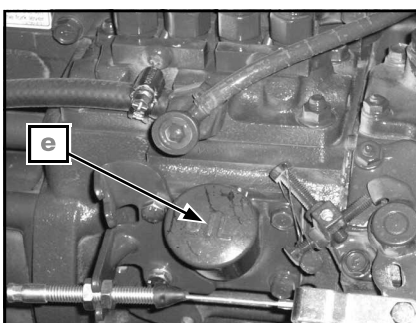

(fig. 3)



Periodic maintenance operations

■ Oil and the oil filter (fig. 1, 2)

The oil and the oil filter should be changed at the intervals indicated in the **LUBRICATION AND MAINTENANCE CHART** in this manual.



WARNING



The first engine oil change should be carried out at the 50 hour service. Initial maintenance is very important and must not be neglected.

- Oil changes should be carried out when the oil is warm.
- Secure the dumper on a level surface.
- Remove the dipstick.
- Clean the oil drain plug area.
- Place a collecting receptacle underneath the oil drain plug.
- Unscrew the oil drain plug.

f- Oil drain cap (fig. 1)



WARNING



The engine oil could be very hot. In order to prevent burns, does not unscrew the filter if the engine is hot. Wait until the engine oil is warm.

- Allow the oil to drain for a while.
- Unscrew the oil filter cover, located on the left side and remove.

g-Oil cartridge filter (fig. 2)

- Clean the base and cover the joint of the new filter element with clean oil.
- Screw in the filter element once again and tighten by hand; do not use mechanical



ENVIRONMENTAL PROTECTION



- Clean any oil spill on the engine.
- Dispose of the oil in appropriately authorised centers.

- Clean gasket area on engine and oil drain plug then.
- Turn and tighten the lubricating oil drain plug fitted with new sealing ring.
- Refill the engine as per the recommended oil level.
- See the **FLUIDS AND LUBRICANTS** section of the manual for capacities and oil quality.
- Start the engine and leave running idle for a few minutes
- Ensure that there are no leaks in any of the oil filter areas and on the oil drain plug.
- Stop the engine.
- Wait a few moments to allow the oil to flow towards the engine crankcase and then check the oil level.
- Refill if necessary.

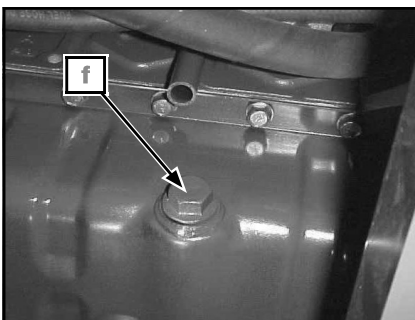

(fig. 1)

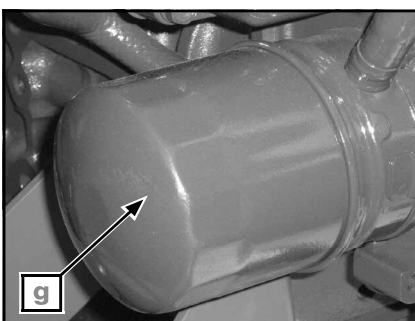

(fig. 2)

Periodic maintenance operations

4.- Engine cooling system

Consult the **FLUIDS AND LUBRICANTS** section of this manual for the coolant specifications to be used.



WARNING



Never remove the reservoir cap if the engine is hot. Wait until the engine is cold. Wait for approximately 20 minutes.

■ Coolant level (fig. 1)

Check the level in the reservoir.

a- Coolant reservoir

Open the right side access cover.

With the vehicle on a level surface, the liquid must be in the upper part of the level indicator, in the MAX mark of the reservoir.

NOTE

- When checking the level at a temperature lower than 20°C, the level may be below the MIN mark.
- A cooling system that requires frequent coolant refills may have leaks or this may indicate that there are engine problems. See an authorized AUSA importer or dealer.

Add coolant up to MAX, mark if required. Never exceed the maximum level.

Use a funnel to avoid spills.

Replace and correctly tighten the filling cap and replace the maintenance access panel.

■ Changing the coolant (fig. 2, 3)

- b- Cylinder block drainage cap.**
- c- Lower radiator hose.**

To make this, follow next steps:

- Open the drainage cock of cylinder block, located at the left side of the engine, for emptying.
- Disconnect the lower radiator hose in order to empty the radiator at this point.
- Before filling the circuit the reservoir drainage cap and the engine drainage cap must be tightened and the hose must be connected again.
- Fill-in through the coolant reservoir.
- Start the engine and wait until the thermostat is open.
- Then with the engine cold, check the level in the coolant reservoir.

Check the intervals for replacing the filter in the **LUBRICATION AND MAINTENANCE CHART** or replace when the circuit must be drained for repairs.

Consult the **FLUIDS AND LUBRICANTS** section of this manual for the coolant specifications to be used.

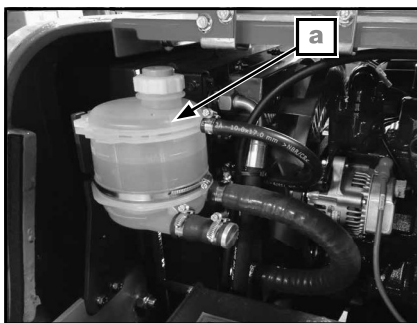

(fig. 1)

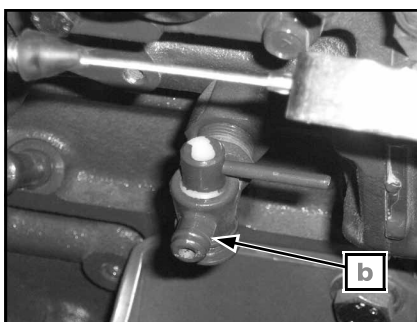

(fig. 2)

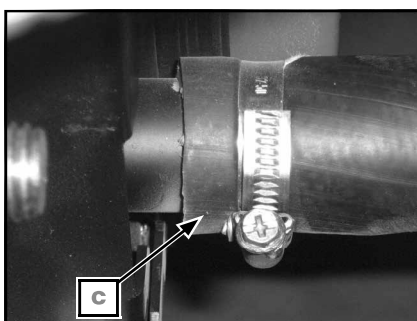

(fig. 3)



Periodic maintenance operations

■ Radiator (fig. 1)

Periodically check the radiator area to ensure it is clean.

d-Radiator fins

Inspect the radiator fins. They must be clean and free of mud, dirt, leaves or any other deposit that would keep the radiator from cooling properly. Never clean the radiator with your bare hands when it is hot. Use gloves to remove external residues from the radiator. Allow the radiator to cool before cleaning.

If water is available in the vicinity, rinse the radiator fins with a hose.

CAUTION

NEVER USE A HIGH PRESSURE WASHER.
USE A LOW PRESSURE WASHER.

Be careful not to damage the radiator when cleaning the fins. Do not use any object or tool that could damage the fins. The fins are thin parts that allow the radiator to cool correctly.

Contact an authorized AUSA importer or dealer to check that the cooling system is functioning correctly.

5.- Air Intake System.

■ Cleaning the air filter (fig. 1)

The air intake to the engine runs through via a double element dry filter.

The life and performance of the engine largely depends on maintaining this filter properly. Check the intervals for replacing the filter in the **LUBRICATION AND MAINTENANCE CHART**.

The internal element of the filter must be replaced on every second replacement of the outer element.

NOTE

- If the dumper is used in dusty areas, inspect more frequently than specified in the **LUBRICATION AND MAINTENANCE CHART**.
- The air filter has a clog indicator (vacuum meter). If the control lamp on the right side of the front operator protector turns on, the filter element must be cleaned or replaced as soon as possible.

CAUTION

Do not start the engine when water is found in the air filter box. When liquids or residues are found, the air filter must be inspected, dried or replaced independently of the condition in which it is found.

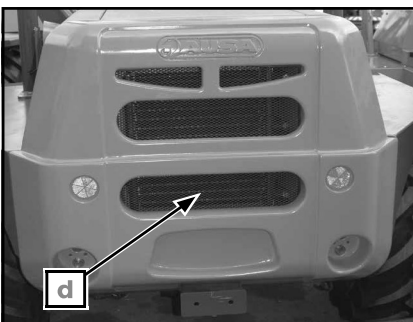

(fig. 1)

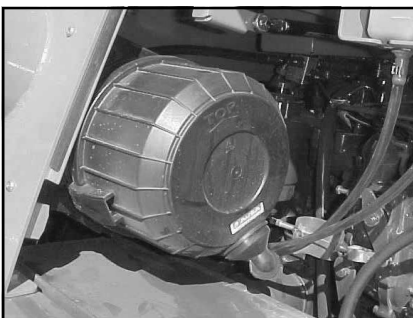

(fig. 2)

Periodic maintenance operations

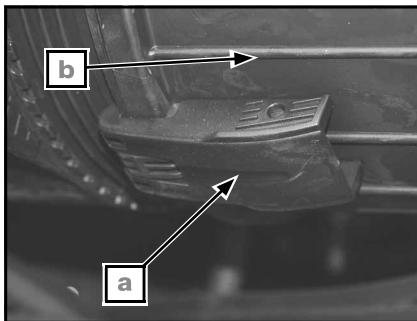

(fig. 1)

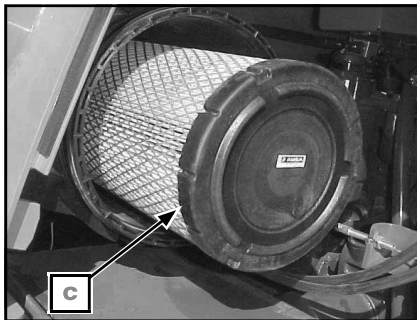

(fig. 2)

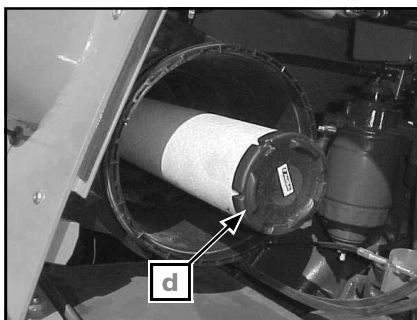

(fig. 3)

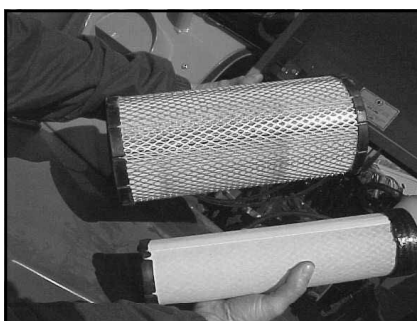

(fig. 4)

■ Removing the air filter (fig. 1, 2, 3, 4)

CAUTION

Never remove or modify any filter component. Poor performance or engine damage could result

Access the filter via the left side cover.

- a- Clamps**
- b- Housing**
- c- Outer filter element**
- d- Internal filter element**

Loosen the clamps of the filter housing and remove the filter elements. Clean the filter elements of the accumulated dust and dirt, by blowing with pressurised air (maximum 5 bar) from inside to outside while turning. Also clean the filter housing interior.

■ Installing the air filter

Reassemble all the parts following the opposite procedure for their removal.



Periodic maintenance operations

6.- Transfer box (fig. 1)

■ Transfer box oil level (fig. 1)

a- Level and filling plug

With the dumper on a level surface, check the oil level in the following way:

- Unscrew the level plug. The oil should spill out of the hole.
- If necessary, add oil through the same level hole.

■ Changing the transfer box oil

Oil changes should be carried out when the oil is warm.

- Clean the area around the drain plug.
- Place a collecting receptacle underneath the oil drain plug.
- Unscrew the oil drain plug.

b-Oil drain plug

- Change the seal in the oil drain plug.
- Clean the transfer box seal area as well as the oil drain plug itself and replace it.
- Refill the transfer box housing as per the recommended oil level. See the **FLUIDS AND LUBRICANTS** section in this manual for capacities and type of oil to be used.
- Ensure that there are no leaks from the oil drain plug.



ENVIRONMENTAL PROTECTION



Clean any oil spillage.

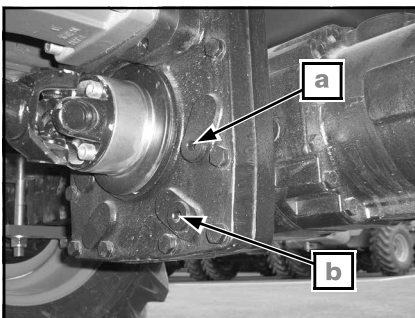

(fig. 1)

Periodic maintenance operations

7.- Axles. (fig. 1, 2)

NOTE

The transfer box is part of the rear axle and the filling, level, drain and breeder plugs are common for both components.

■ Differentials oil level

a- Level plug

b-Filling and bleeder plug

With the dumper on a level surface, check the oil level in the following way:

- Unscrew the level plug. The oil should spill out of the hole.
- If necessary add oil via the filling and bleeder plug or via the level plug.

■ Changing differentials oil

Oil changes should be carried out when the oil is warm.

- Clean the area around the drain plug.
- Place a a collecting receptacle underneath the oil drain plug.
- Unscrew the oil drain cap.

c- Oil drain cap

- Change the seal in the oil drain plug.
- Clean the drain hole area, the oil drain plug itself and replace it.
- Refill the differential housings as per the recommended oil level. See the **LIQUIDS AND LUBRICANTS** section in this manual for capacities and type of oil to be used
- Ensure that there are no leaks from the oil drain plug.



ENVIRONMENTAL PROTECTION



Clean any oil spillage.

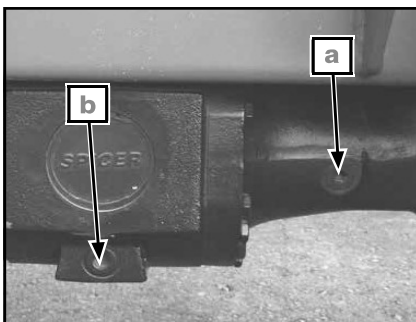

(fig. 1)

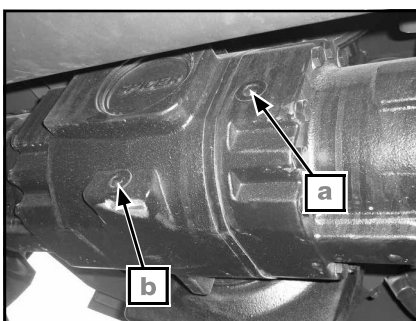

(fig. 2)



Periodic maintenance operations

■ Front & rear axle wheel reduction (fig. 1, 2)

a- Wheel reduction plug

For wheel reduction filling in and oil level, use the cap placed in the wheel hub.

Turn the wheel until the mark "Oil stand-Oil level" (**fig. 2**) is horizontal. Remove the plug and fill in until overflow. To proceed to drain the oil, remove the plug and place the hole in the lower part of the wheel reduction (**fig. 3**).



WARNING



Never remove the drain plug of the final reductions when the oil is hot. The gases formed in the interior may cause injury.

Always place the cap on the top of the wheel reduction (**fig. 1**) and, once opened, turn until reaching the desired position.

See the LUBRICATION AND MAINTENANCE CHART section in this manual for periodicity and type of oil to be used

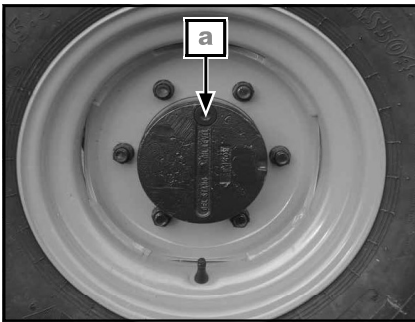

(fig. 1)

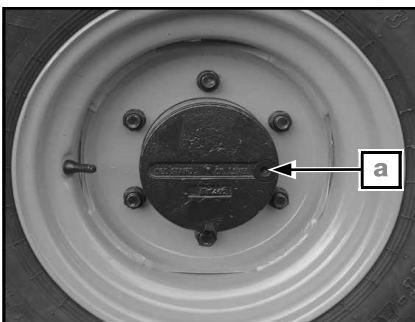

(fig. 2)

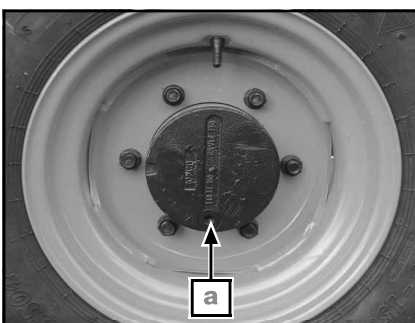

(fig. 3)

Periodic maintenance operations

8.- Service and parking brake

Check the following to keep the brakes in good operating conditions.

- System fluid leaks
- Spongy feel to the pedal and no feeling of seizing.



WARNING



Brake fluid replacement or any brake system repair should be performed by an authorized AUSA importer or dealer.

■ Parking brake

If activating the parking brake does not immobilize the dumper, the cables must be tightened. To do so:

a- Cable cover

Tightening of the handbrake (fig. 1, 2)

- Can be tightened by both ends of the cable housing.
- Always maintain cables without excessive dubbings and the link lubricated.

■ Service brake

The brakes require no adjustment.

Contact your authorized AUSA importer or dealer for system check.

■ Brake fluid level (fig. 3)

The tank is located upon the brakes pump, under the floor plate.

b- Brake fluid tank

With dumper on a level surface, liquid should be between MIN. and MAX. level marks.

NOTE

- Never exceed the maximum level.
- Use a funnel to avoid spills.
- Place and tighten the filling cap correctly .



DANGER



A brake system that frequently needs its brake fluid refilled may have leaks. See an authorized AUSA importer or dealer.

■ Changing the brake fluid

Check the replacement schedule in the LUBRICATION AND MAINTENANCE CHART or replace when the circuit is drained for repairs. To do so, contact an authorized AUSA importer or dealer.

■ Brake master cylinder (fig. 1)

If the pedal has too much play, this can be corrected using the pedal tappet that drives the brake master cylinder, which has nut – locknut for adjustment.

c- Pump tappet

Allow the tappet to have play of between 1 and 1.5 mm (0.039 and 0.059 in), ensuring that the pump has no internal pressure.

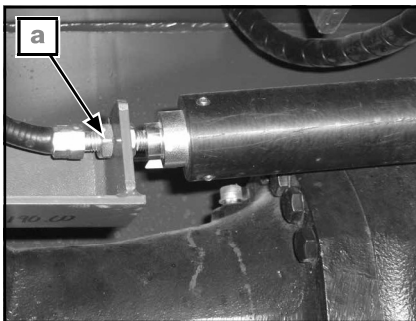

(fig. 1)

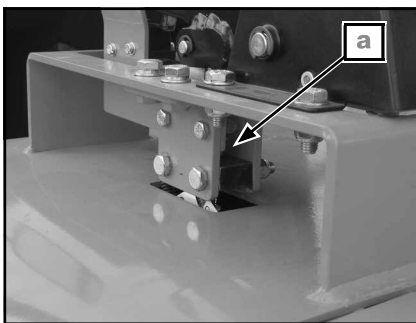

(fig. 2)

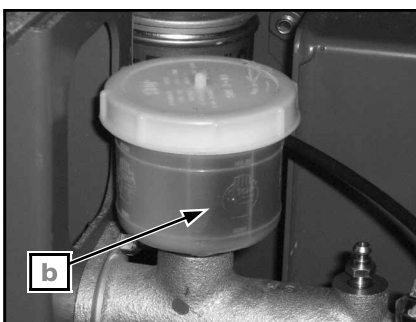

(fig. 3)

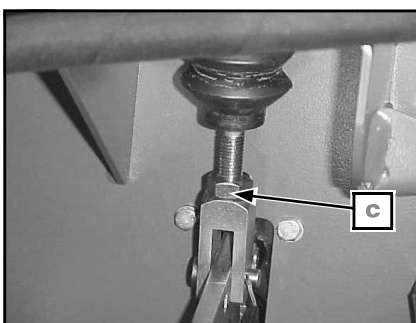

(fig. 4)



Periodic maintenance operations

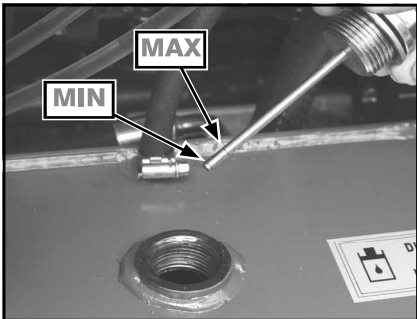

(fig. 1)

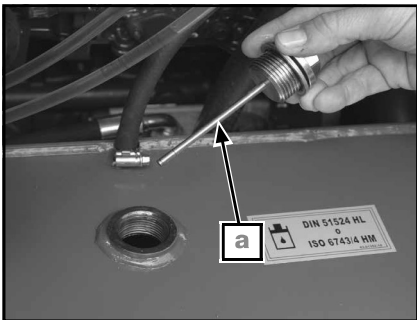

(fig. 2)

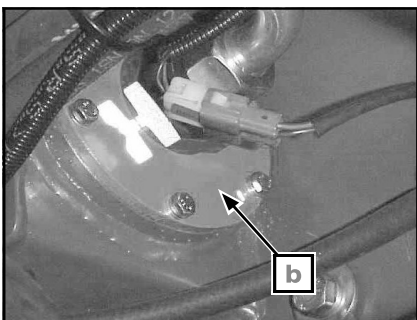

(fig. 3)

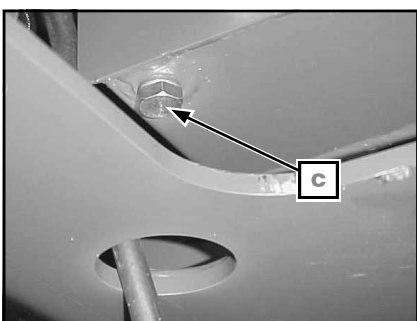

(fig. 4)

9.- Hydraulic Circuit.

■ Hydraulic oil level (fig. 1, 2)

The hydraulic oil tank is located on the left side of the engine compartment. Place that the dumper is on a level surface.

The oil level must always be checked with the hopper in the lower position and with the engine stopped.

a- Filling cap and dipstick

Unscrew the filling cap with incorporated dipstick. The oil level should be between the MIN. and MAX. level marks.

If necessary, add oil through the same filling hole. Use a funnel to avoid spills. Place and tighten the filling cap correctly and close the cover.

NOTE

- Never exceed the maximum level.
- A hydraulic system which frequently required oil indicates may have leaks. See an authorized AUSA importer or dealer.

■ Changing the hydraulic oil (fig. 3, 4)

b- Hydraulic oil strainer filter

c- Tank drain plug

Oil is drained via the plug located on the lower part of the tank.

- Clean the area around the drain plug.
- Place a collecting receptacle underneath the oil drain plug.
- Unscrew the drain plug.

In the hydraulic circuit there is a suction filter located inside the tank. It is a metallic filter that must be cleaned every time the hydraulic oil is replaced.

Change the seal in the oil drain plug. Clean the tank seal area and the oil drain plug and re-assemble it.

Refill the tank as per the recommended oil level. See the **LIQUIDS AND LUBRICANTS** section in this manual for capacities and type of oil to be used.

Ensure that there are no leaks from the oil drain cap.



ENVIRONMENTAL PROTECTION



Clean any oil spillage.

Periodic maintenance operations

■ Filter of the hydrostatic transmission (fig. 1, 2, 3)

The hydrostatic circuit is equipped with a cartridge filter. Replace it as regularly as it is indicated in the **LUBRICATION AND MAINTENANCE CHART**.

The support of the filter goes provided of an obturation indicator (vacuummeter) **(a)**. With the engine started, the needle has to be located in the green area or as maximum in the yellow one. If it comes closer or it locates in the red area, to replace the cartridge filter as soon as possible.

- a- Vacuummeter**
- b- Oil Tap**
- c- Cartridge filter**

■ Cartridge filter substitution

Turn off the tap **(b)**.

Loose the filter **(c)**. Clean the base and grease with clean oil the joint of the new filter. Screw it in its support and tighten it without using mechanical means.

CAUTION

Take care to correctly tighten the filter otherwise the fuel system could take in air causing engine failure.

Turn on the tap again **(b)**.

CAUTION

Remember to open the oil tap again and to fasten the cartridge filter properly **(c)**, otherwise it would cause fatal damage to the hydrostatic transmission.

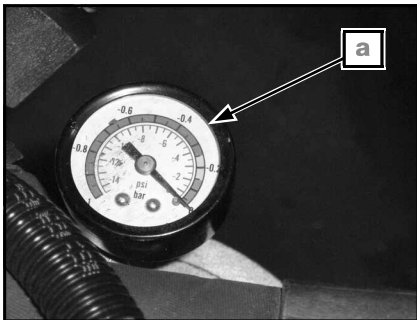

(fig. 1)

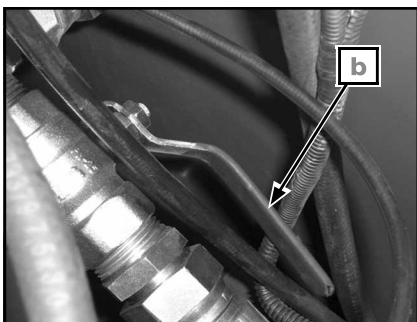

(fig. 2)

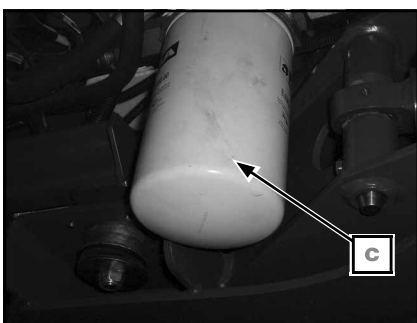

(fig. 3)



Periodic maintenance operations

■ Safety valve setting (fig. 1, 2)

There are two safety valves to avoid excess pressure in the steering circuit and the skip movements circuit.

a-Steering circuit safety valve

b-Skip movements circuit safety valve

The first is located on the hydraulic steering and the second in the control valve body. These valves are set at the correct working pressure in factory, but the settings need to be checked periodically and adjusted if necessary. This work must only be done by trained technicians with knowledge of hydraulics and with the appropriate tools. Pressures should never exceed those indicated in the **SPECIFICATIONS** section in this manual.

- Hydraulic steering valve: Remove the cap by unscrewing it and use a screwdriver to turn the internal screw in a clockwise direction to increase the hydraulic pressure and counter-clockwise to reduce it.
- Skip movements circuit valve: Remove the plastic cover, then loosen the locknut and turn the screw a clockwise direction to increase the hydraulic pressure and counter-clockwise to reduce it.

■ Hydraulic hoses

All hydraulic hoses must be changed at least every 6 years.

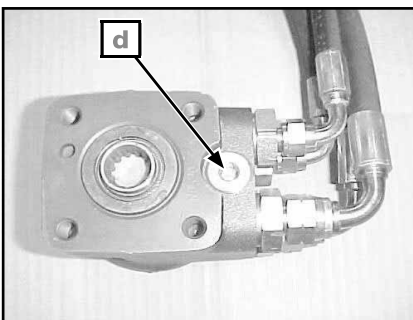

(fig. 1)

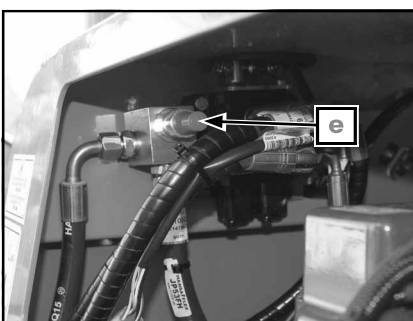

(fig. 2)

Periodic maintenance operations

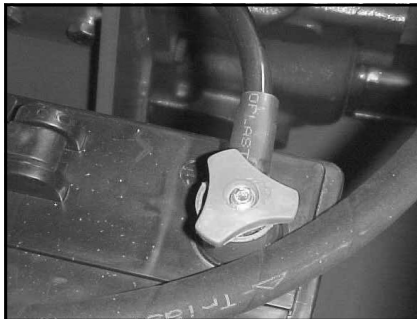

(fig. 1)

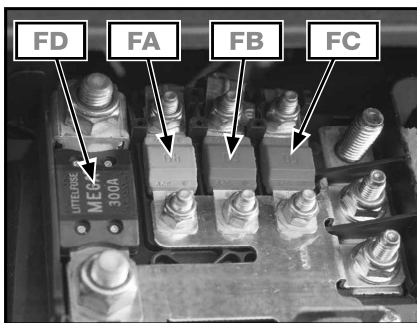

(fig. 2)

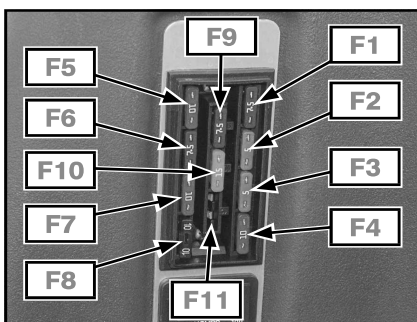

(fig. 3)

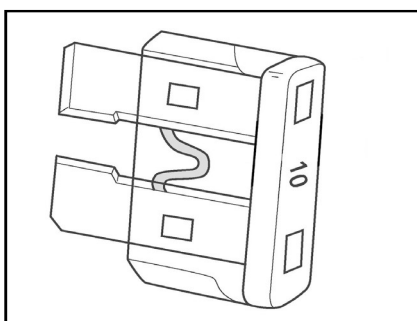

(fig. 4)

10.-Electric circuit.

■ Battery

The battery is located under the foot rest plate on the left side.
Check that the battery has no external damage or electrolyte leaks.
Clean the battery posts of rust.
Apply dielectric grease or vaseline on the positive post to protect it from rust.

WARNING

Never charge the battery when it is mounted on the dumper.

■ Battery isolator (fig. 1)

There is a battery isolator in the negative post (-).
Disconnection of the battery is recommended during repairs to the electrical wiring, welding and long storage periods.

■ Fuses

If a fuse is damaged, replace it with another fuse with the same range.

CAUTION

Do not use fuses with higher range, since this may cause serious damage. The fuses are located in a box behind the battery and the instrument and control panel in front of the operator.

Box fuses on the battery positive tip (fig. 2)

FA: (+15) Preheater unit maxifuse	(40A)
FB: (+50) Starter motor relay maxifuse	(50A)
FC: (+30) Maxifuse	(50A)
FD: Starter motor fuse	(300A)

Instruments panel and controls fuses (fig. 3)

F1: (+30) warning fuse	(7,5A)
F2: Reverse speed buzzer/left position light fuse	(5A)
F3: Position light fuse	(5A)
F4: Low beam fuse	(10A)
F5: High beam fuse	(10A)
F6: (+15) Joystick fuse	(7,5A)
F7: (+15) Front and reverse solenoids + horn fuse	(10A)
F8: (+15) Starter/ stop engine solenoid fuse	(10A)
F9: (+15) Warning lights fuse	(7,5A)
F10: (+15) Rotating beacon fuse	(15A)
F11: (+15) Optional fuse.....	(10A)
(+30) Trackunit optional fuse.....	(1A)
(+30) Digicode optional fuse.....	(5A)

To remove the fuses from the box, remove the cover and pull the fuse.

■ Checking the fuses (fig. 4)

Check whether the internal filament is blown.

TYPICAL PROCESS

- a- Fuse
- b-Check if it is blown



Periodic maintenance operations

11.-Wheels.

Unless it is essential for the type of work to be carried out, the use of solid tires is not recommended, since this amplifies the effects of impacts on the transmission and the operator.

This operation is very important when the dumper is used in salt water or muddy environments. Remove the wheel nuts one by one, lubricate each one and screw them on again.

■ Re-tighten the wheels

The wheel nuts should be retightened weekly or 50 operation hours.

Wheel nuts torque: 330 ± 30 Nm.

■ Tire pressure



WARNING



Tire pressure largely affects the steering and stability of the dumper. A low tire pressure in the tires could make them deflate and spin out. A high pressure can make them blow out. Always comply with the recommended pressure. Since a relatively high tire pressure is necessary, do not use a manual pump. Inflating the wheels could be dangerous if the operation is not carried out with caution. If possible, it is recommended that this operation be carried out by specialists in the field.

We recommend that the following instructions are followed, specially for the front wheels:

- Park the dumper on flat ground with the engine off.
- When the tires are cold, always inflate them, to the pressure indicated in the **SPECIFICATIONS** section of this manual before starting to work with the dumper.
- Tire pressure changes according to the temperature and altitude. Recheck the pressure if one of these conditions changes.
- The pressure must be checked and the tires inflated with a pressure meter in good operational condition and equipped with a nozzle that has a safety clamp, to prevent it slipping from the tire valve during inflation.
- Use gloves to avoid any injury to the hands by any air nozzle malfunctions.
- If the tire is being inflated away from the dumper, first protect it with a special protection cage designed for this purpose.
- It is recommended that you carry an anti-puncture repair kit.

■ Wheel/Tire condition

Check the tires for possible damage or wear. Replace if necessary.

Do not rotate the tires if they are directional.

For correct operation, a specific direction must be maintained when they are rotated.

■ Removing the wheel (fig. 1)

Loosen the nuts and raise the dumper. Place a support beneath it. Remove the nuts and then remove the wheel.

When assembling, apply lubricant to the threads. Slowly tighten the nuts in a criss-cross sequence, applying a final torque of 330 ± 30 Nm.

a- Coned part of the wheel nut

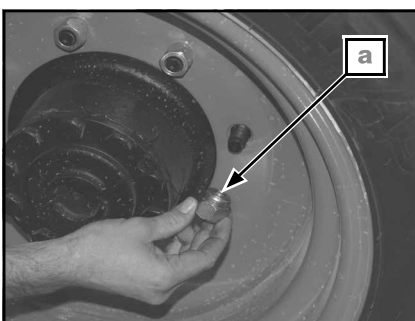

(fig. 1)



WARNING



Always use the recommended wheel nuts. Using a different nut could cause damage to the wheel rim.

Periodic maintenance operations

12.-Cable lubrication

All cables (**fig. 1**) must be lubricated with cable lubricant.



WARNING



Using another lubricant could cause the cable or control to malfunction (parking brake, etc.). Always wear eye protectors and gloves when lubricating cables.

13.-Body/Chassis

■ Engine Area

Check the engine compartment to see if there is any damage or leak. Ensure that all rubber hoses are free from cuts, splits, cracks or damage of any kind and that the fittings are correctly fitted. Examine the support devices for the exhaust, battery and tanks. Check the electrical connections for corrosion and tension on the cables. Replace or repair damaged parts.

■ Chassis supports

Check the condition and tighten all dumper supports. Retighten if necessary.

■ Dumper cleaning and protection

Never use water at high pressure to clean the dumper. ONLY USE LOW PRESSURE WATER. High pressure water can cause electrical and mechanical damage. Damaged painted parts must be repainted to prevent corrosion. When required, wash the body with soap and water (use only neutral soap) Apply non-abrasive wax.

CAUTION

Never clean plastic parts with inappropriate detergent, degreasing agents, solvents, acetone, etc.

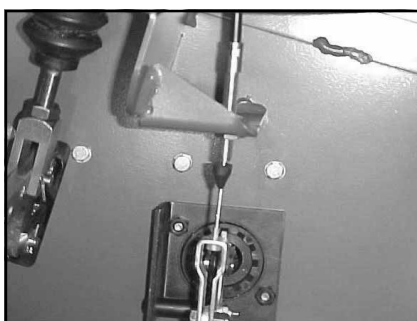

(fig. 1)



76



D 250 AHG / D 350 AHG / D 400 AHG / D 450 AHG

Lubrication and maintenance chart

	EVERY												
	Initial inspection (50 h)	100 h.	200 h.	400 h.	600 h.	800 h.	1000 h.	1500 h.	3000 h.	Every day	Every week	Every year	Every 2 years
I: Inspect, verify, clean, lubricate, replace if necessary													
C: Clean													
L: Lubricate													
R: Replace													
ENGINE													
Oil and oil filter (1)	R		R							I		R	
Alternator belt (1)	I	I			R								R
Engine mounts					I								
Visual check of exhaust smoke			I										
Valve clearance						I							
FUEL SYSTEM													
Air filter element (4)		C			R (5)						I	R	
Intake air line			I										R(6)
Fuel pipes and clamps											I		R(2)
Fuel filter cartridge				R									
Fuel prefilter (1)				R									
Fuel tank and oil strainer					C								
Fuel injection nozzle injection pressure (2)								I					
Injection pump (2)									I				
Fuel injection timer (2)									I				
COOLING SYSTEM													
Radiator hoses and clamps bands			I										R(2)
Water jacket (internal)				C									
Water jacket (external)										I/C			
Coolant										I			R
ELECTRICAL SYSTEM													
Battery electrolyte	I	I											
Battery connections											I		
Battery													R
Electric harness and loose connections				I									
Dash panel indicators (3)											I		
Lighting and signalling (if fitted)											I		
HYDRAULIC CIRCUIT													
Oil, drain plug magnet and suction strainer.	R/C							R/C			I		
Hydraulic cartridge filter (1)	R							R					
Bucket movements (3)										I			
Pipes, hoses and fittings damages or leaks			I							I			
Steering movements (3)											I		
Hoses	REPLACE AT LEAST EVERY 6 YEARS												
TRANSFER BOX													
Oil (1)	R							R					R

- (1) Initial inspection. The initial maintenance is very important and must not be neglected.
- (2) To be performed by an authorized AUSA dealer.
- (3) Daily inspection item.
- (4) More often under severe use such dusty area, sand, snow, wet or muddy conditions.
- (5) After cleaning 6 times.
- (6) replace only if necessary



D 250 AHG / D 350 AHG / D 400 AHG / D 450 AHG



	EVERY												
	Initial inspection (50 h)	100 h.	200 h.	400 h.	600 h.	800 h.	1000 h.	1500 h.	3000 h.	Every day	Every week	Every year	Every 2 years
I: Inspect, verify, clean, lubricate, replace if necessary													
C: Clean													
L: Lubricate													
R: Replace													
Oil leaks											I		
Tightness of all nuts and bolts							I						
AXLES (FRONT AND REAR)													
Differential axles oil and planetary reduction (1)	R			I			R					R	
Oil leaks											I		
Screws and nuts torque	I										I		
Chassis fixation screws (torque)						I							
Wheel hub bearings adjustment							I						
Cardan joint fixation screws (torque)				I									
Flange fixation nut (torque)				I									
Condition of tires and pressures											I		
BRAKES													
Brake fluid (3)							R			I			
Parking brake adjustment (3)	I										I		
GREASING POINTS													
Centre pivot											L		
Nipples (see section "GREASING POINTS" in this Manual)											L		
Controls and articulations (throttle, rams...)											L		
BODY/FRAME													
ROPS frame											I		
Seat belt (3)										I			
Foot plate and access steps and handles (3)										I/C			
Guards and covers (3)										I			
Plates and decals (3)										I			
Centre pivot pin fixation nut								I					
Safety system / chassis locking (connecting bar) and bucket safety lock										I			
Engine compartment cover locks											I		
Counterweight fastenings (2)					I								

- (1) Initial inspection. The initial maintenance is very important and must not be neglected.
- (2) To be performed by an authorized AUSA dealer.
- (3) Daily inspection item.
- (4) More often under severe use such dusty area, sand, snow, wet or muddy conditions.
- (5) After cleaning 6 times.
- (6) replace only if necessary

See annex for instructions of accessories or special finishes (if equipped)



Greasing points

■ Greasing points (fig. 1, 2, 3, 4, 5, 6)

6 nipples on the central articulated joint and on the tipping frame (a)

2 nipples on the steering ram (b)

3 nipples on the universal drive shaft joints, one on each cross and one on the splines (c)

2 nipples on each ram, one on each articulated joint pin (d)

1 nipple on each skip pivot pin (e)

3 nipples on the swivel crown (f)

1 nipple on the brake pedal pin (g)

See **LUBRICATION AND MAINTENANCE CHART** for greasing intervals.

See **LIQUIDS AND LUBRICANTS** for the type of grease to be used.

🛠. 50h

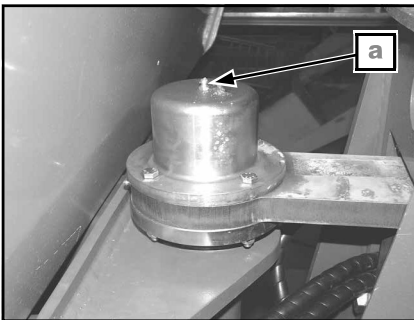
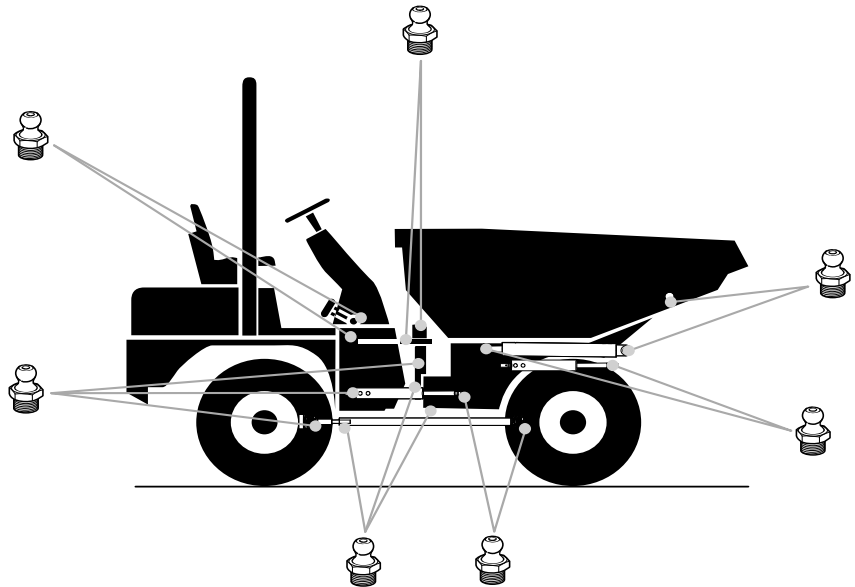

(fig. 1)

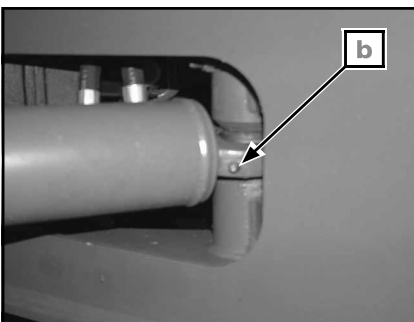

(fig. 2)

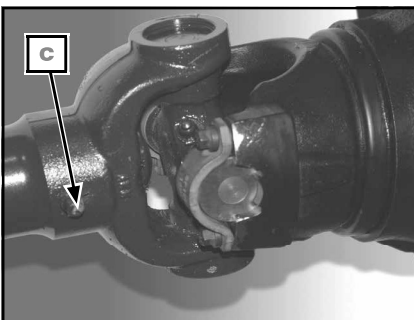

(fig. 3)

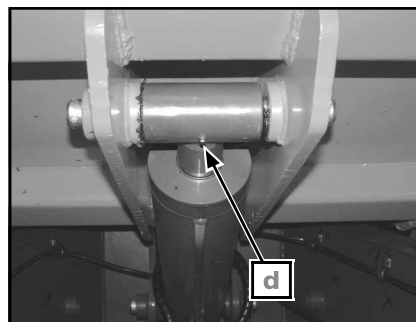

(fig. 4)

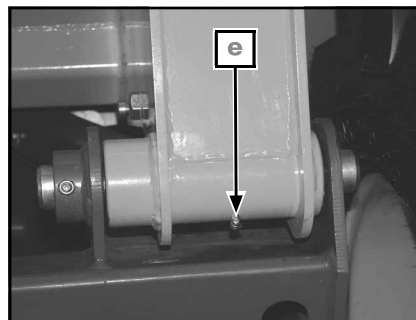

(fig. 5)

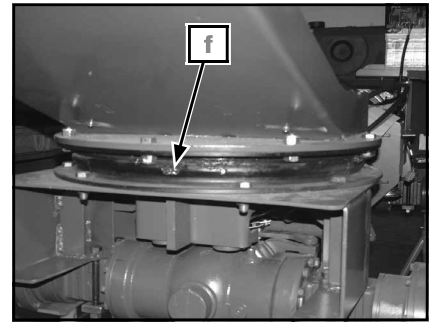

(fig. 6)

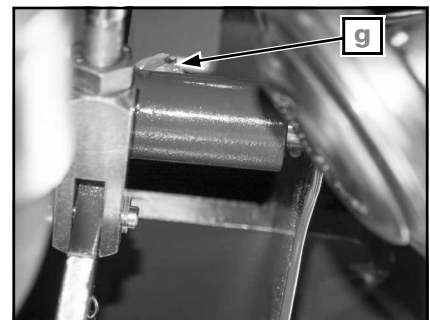

(fig. 7)



D 250 AHG / D 350 AHG / D 400 AHG / D 450 AHG



79

Electric diagram
Hydraulic diagram

Available in the AUSA Service private Zone in the Website
Contact an authorised AUSA importer o Dealer



Identification of failures in hydrostatic transmissions

FAILURES	POSSIBLE CAUSE	CHECK	LOCATION	CORRECT VALUES
The machine does not move neither forward nor in reverse	Low oil level	Oil level	Oil tank	MAX mark
	Suction hose is bent or squashed	Suction line	Suction hose	
	Hydraulic oil cartridge is clogged	Clogged indicator (vacuum meter)	Suction filter	< 0,3 bar / 4.35 psi
	Faulty coupling		Hydrostatic motor or pump coupling	
	Boost pressure pump turns opposite to the engine	Charge pressure	"M3" port in pump	24 ÷ 28 bar / 350 ÷ 400 psi
	Faulty charge pump			
	Faulty hydrostatic motor			
	Directional block does not shift	Resistance and current. Directional block operation.	Directional solenoids in pump	
	Faulty Inching pedal system	Travel and connections	Pedal and electric connections	
Non instant motion response, abnormal	Loose suction hydraulic fittings	Hoses or fittings sealing and suction strainer filter.	Hydraulic line	
	Oil is air emulsified or oil level is low	Oil level, hoses, fittings sealing and suction oil strainer.	Oil tank, hydraulic line	
	Vacuum filter	Clogged indicator (vacuum meter)	Vacuum filter	< 0,3 bar / 4.35 psi
Engine is overloaded	Faulty Inching pedal system	Potentiometer signals	Electrics	
	Low engine power or faulty engine	Engine does not accelerate at max. load	Engine	85 ÷ 95 % max rpm. of engine
Low traction power	Working pressure too low	Working pressure	Working pressure ports "Ma" and "Mb" in pump.	Recommended max. working pressures 345 or 410 bar / 5000 or 5940 psi.
	Engine does not work at nominal speed or it's overloaded	Engne does not accelerate to max. charge	Engine	85 ÷ 95 % max rpm. of engine
	Low charge pressure	Charge pressure	Charge pressure port "M3" in pump.	24 ÷ 28 bar / 350 ÷ 400 psi
	Working pressure too low	Working pressure	Working pressure ports "Ma" and "Mb" in pump.	Recommended max. working pressures 345 or 410 bar / 5000 or 5940 psi.
	Faulty Inching pedal system	Potentiometer signals	Electrics	
	Faulty solenoids or swapped over	"Y1" and "Y2" solenoids	Hydrostatic motor electric wiring	"Y1" towards front. Proportional solenoid. "Y2" towards rear. On - off solenoid."
	Hydraulic Oil overheating	Dirt in radiator	Oil cooler	
Hydraulic oil overheating	Faulty hydrostatic motor. Internal leaks.	Charge pressure	Charge pressure with a gauge on pump port "M3"	24 ÷ 28 bar / 350 ÷ 400 psi
	Low oil level	Oil level	Oil tank	
	Faulty hydraulic oil	Oil degradation an contamination	Oil tank	
	Suction line is not sealed	Hoses, fittings and oil filters sealing.	Hydraulic line	
	Faulty high pressure relief valves	Working pressure	Working pressure ports "Ma" and "Mb" in pump.	Recommended max. working pressures 345 or 410 bar / 5000 or 5940 psi.
Transmission overspeed	Radiator is dogged	Dirt in radiator		
	Max. engine RPM is higher than recommended	Max. RPM on the engine	Engine	
Irregular running	Min. displacement adjustment incorrectly set	Hydrostatic motor plate stopper measurement	Hydrostatic motor	Consult for each model
	Faulty solenoids or swapped over	"Y1" and "Y2" solenoids	Hydrostatic motor electric wiring	"Y1" towards front. Proportional solenoid. "Y2" towards rear. On - off solenoid."
Insufficient acceleration	Low engine power	Throttle system linkage.	Engine	
	Faulty solenoids or swapped over	"Y1" and "Y2" solenoids	Hydrostatic motor electric wiring	"Y1" towards front. Proportional solenoid. "Y2" towards rear. On - off solenoid."



EC DECLARATION OF CONFORMITY

The manufacturer **AUSA Center, S.L.U.**, established on c/ Castelladral, 1, 08243 – Manresa – Barcelona – Spain, declares that the machine assigned below:

Generic denomination: **DUMPER**
Model/Type: _____
Serial number: _____

fulfils all relevant provisions of the machinery Directive 2006/42/EC

and it conforms with the next European Directives and Regulations:

Electromagnetic Compatibility Directive 2014/30/EC

Sound level Directives of machinery used outdoors, 2000/14/EC and Regulation (EC) No 219/2009

Regulation (EU) 2016/1628 on requirements relating to gaseous and particulate pollutant emission limits and type-approval for internal combustion engines for non-road mobile machinery

based on the following European Standards:

EN 474-1 – Earth-moving machinery – Safety – Part 1: General requirements.

EN 474-6 – Earth-moving machinery – Safety – Part 6: Requirements for dumpers.

The certification procedure has been carried out in accordance with the provisions relating to non-dangerous machinery in the above mentioned Directives.

Name and address of the person authorized to compile the technical file:

Mr. _____

AUSA Center, S.L.U.

c/ Castelladral, 1, 08243 – Manresa – Barcelona

Given at Manresa on __ / __ / ____



AUSA Center, S.L.U.
c/ Castelladral, 1- P.O.B. 194
08243 MANRESA (Barcelona) España

Tel. 34-93 87 47 311
Fax 34-93 874 12 11
Web: <http://www.ausa.com>



INTENTIONALLY BLANK PAGE





AUSA Center

C/ Castelladral 1
08243 Manresa - BARCELONA
+34 93 874 73 11
ausa@ausa.com

AUSA Spain

Pol. Ind. Coslada-Marconi 15-17
28823 Coslada - MADRID
+34 91 669 00 06
ausa.madrid@ausa.com

AUSA France

11 Rue Gustave Eiffel
66350 TOULOUGES
+33 (0) 468 54 38 97
ausa.france@ausa.com

AUSA Central Europe

+49 (0) 2384 9889905
info@ausa.de

AUSA U.K.

+44 (0) 7703 609009
ausa.uk@ausa.com

AUSA U.S.

400 Continental Blvd 6th Floor
90245 El Segundo, CA.
+1 (310) 426 2305
ausa.us@ausa.com

AUSA Brasil

Avenida Belizario Ramos 2276
Lages - SC, 88506-000
+55 11 9 87866014
ausa.brasil@ausa.com

AUSA Xina

Room 403, Moma Building, N.199
Chaoyang bei road, Chaoyang District
100026 BEIJING
+86 10 8598 7386
ausa.china@ausa.com



Distribuído por Distribué par Distributed by Verteilt durch :

